

ANBAUANLEITUNG

mounting instructions • instructions de montage • instrucciones de montaje • istruzioni di montaggio

KFT.07.975.65100/B

beinhaltet • contains • contient • contiene • contiene

KFT.07.975.30000/B

KFT.00.152.36000

HSK.00.745.11000/B

LOC.00.745.10200

Item number: **KFT.07.975.30000/B**

Revision: **00** · Date: **11 - 2023**

PRO side carrier

 ~ 0.5 h.

EASY     DIFFICULT

ENGLISH Thank you for choosing this premium product from SW-MOTECH. Visit our online shop for more information (e.g. model assignments). Required documents (e.g. national type approval) are available there for you to download.

Please read and understand all the instructions, safety information and warnings in these mounting instructions before mounting and using the product in order to avoid injury and damage. Keep these mounting instructions for reference.

This product was developed for vehicles in factory condition. Compatibility with original accessories or accessories from other manufacturers cannot be guaranteed.

These mounting instructions have been prepared to the best of our current knowledge. No legal claims relating to accuracy can be made. Errors and omissions excepted. We reserve the right to make technical and design changes. The copyright is held by SW-MOTECH.

SAFETY WARNING SYMBOL

 This warning symbol is used in these mounting instructions to warn of deadly dangers, injuries or other hazards. The words **DANGER**, **WARNING** or **CAUTION** are used as part of this warning symbol to convey important safety messages and information relating to the installation and use of this product. These words, together with the safety warning symbol, mean:

 **DANGER:** Indicates a hazardous situation which, if not avoided, will result in death or serious injury!

 **WARNING:** Indicates a hazardous situation which, if not avoided, may result in death or serious injury!

 **CAUTION:** Indicates a hazardous situation which, if not avoided, may result in minor or moderate injury!

 **NOTE:** Important information, but not relating to a risk of death or injury (property damage only)!

GENERAL INFORMATION

 **WARNING:** Assembly and/or maintenance of this product requires advanced technical skill, appropriate tools, and a good understanding of tool usage and torque specifications. For your own safety, SW-MOTECH recommends having the assembly and/or maintenance carried out by a qualified and certified motorcycle workshop.

 **WARNING:** If you do choose to assemble this product yourself, carefully and fully read the mounting instructions before assembly and use, and follow all instructions to avoid serious injury or death. Also observe all relevant information in the vehicle manual when mounting or using the product. IF YOU DO NOT UNDERSTAND ANY PART OF THESE MOUNTING INSTRUCTIONS OR NEED AN EXPLANATION AS TO A SPECIFIC INSTRUCTION, DO NOT ATTEMPT TO INSTALL THIS PRODUCT WITHOUT CONSULTING SW-MOTECH FOR ASSISTANCE!

PREPARATION: Read the mounting instructions carefully and make sure that all parts on the parts list are available.

 **CAUTION:** Ensure that your vehicle is standing securely. Switch off the engine and remove the ignition key. Allow the engine/exhaust to cool down if necessary. Disconnect the battery when working on the electrical system. Only use proper tools and always wear safety goggles and gloves during assembly and maintenance. Have a second person help you with assembly and maintenance.

ASSEMBLY: All parts and connections removed from the vehicle must be reinstalled according to the vehicle manufacturer's specifications or replaced with parts and hardware supplied by SW-MOTECH.

 **WARNING:** Secure all threads with a medium-strength liquid threadlocker, unless otherwise specified.

 **DANGER:** Tightening torques not defined by SW-MOTECH must be obtained from the vehicle manufacturer or a certified motorbike workshop.

FUNCTIONAL CHECK: After mounting the product, ensure that no moving parts are obstructed and that the function of the vehicle is not impeded. Cables and hoses must not rub against each other and/or be hindered in any way.

 **WARNING:** Carry out a comprehensive functionality check before you start to drive. Check the tightening torque of all connections and the tight fit of the product after the first 50 km and then at regular intervals. Mounted accessories can change the handling and stability of the vehicle.



SW-MOTECH GmbH & Co. KG
Ernteweg 7-10
35282 Rauschenberg
Germany



 info@sw-motech.com
 www.sw-motech.com



Take note of the symbols and what they mean in the ASSEMBLY section. If the term OEM appears in the ASSEMBLY section, the vehicle manufacturer's specifications must be observed and applied.



If you have any questions, please don't hesitate to contact our Customer Service team or our distributors. You can find our telephone number and a list of our distributors in our online shop:

www.sw-motech.com



Use thread locker: Indicates that a thread must be coated with liquid thread locker. H (HIGH): high strength; M (MEDIUM): medium strength; L (LOW): low strength.



Tighten/note the tightening torque information:

Indicates the tightening torque of a part specified by SW-MOTECH or the vehicle manufacturer (OEM).

PARTS LIST - READ AND KEEP MOUNTING INSTRUCTIONS!

2	<p>1</p>  <p>KFT.22.892.001.11</p> <p> 4/4</p>	<p>2</p>  <p>M8 x 60; DIN 6912 SC.ST.08.060.02.6912.088</p> <p> 2/2</p>	<p>3</p>  <p>M8 x 40; DIN 6912 SC.ST.08.040.02.6912.088</p> <p> 2/2</p>	<p>4</p>  <p>ø 8,4; DIN 125 US.ST.084.02.125</p> <p> 4/4</p>	<p>5</p>  <p>Ø 18 / ø 8,4 / h 24 DB.ST.0180.0084.0240.02</p> <p> 2/2</p>	<p>6</p>  <p>KFT.07.975.001L.11</p> <p> 1/1</p>
7	<p>7</p>  <p>KFT.07.975.001R.11</p> <p> 1/1</p>	<p>8</p>  <p>M6 x 25; DIN 6912 SC.ST.06.025.02.6912.088</p> <p> 2/2</p>	<p>9</p>  <p>M6 x 16; DIN 6912 SC.ST.06.016.02.6912.088</p> <p> 2/2</p>	<p>10</p>  <p>ø 6,4; DIN 125 US.ST.064.02.125</p> <p> 4/4</p>	<p>11</p>  <p>Ø 18 / ø 6,4 / h 10 DB.ST.0180.0064.0100.02</p> <p> 2/2</p>	
3	<p>12</p>  <p>KFT.07.975.971.01.11</p> <p> 1/1</p>	<p>13</p>  <p>KFT.07.975.972.01.11</p> <p> 1/1</p>	<p>14</p>  <p>KFT.00.152.SV.8</p> <p> 1/1</p>	<p>15</p>  <p>KFT.06.871.005.11</p> <p> 1/1</p>		

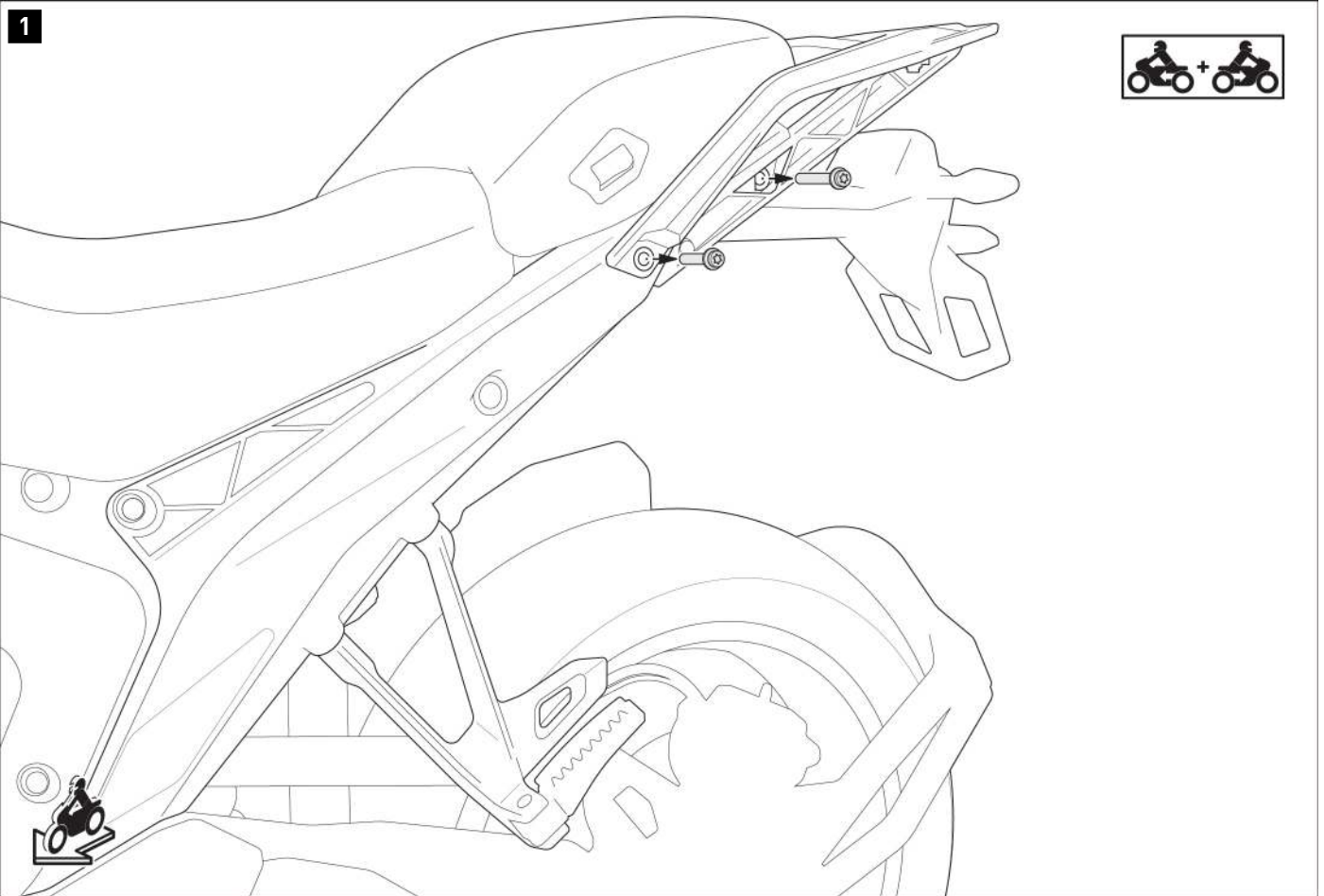

- ▲ **WARNING: Always wear eye and hand protection!**
- ▲ **WARNING: Always use the proper tools!**

Remove the screws shown from the rear of the vehicle on both sides.

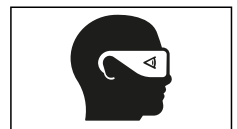

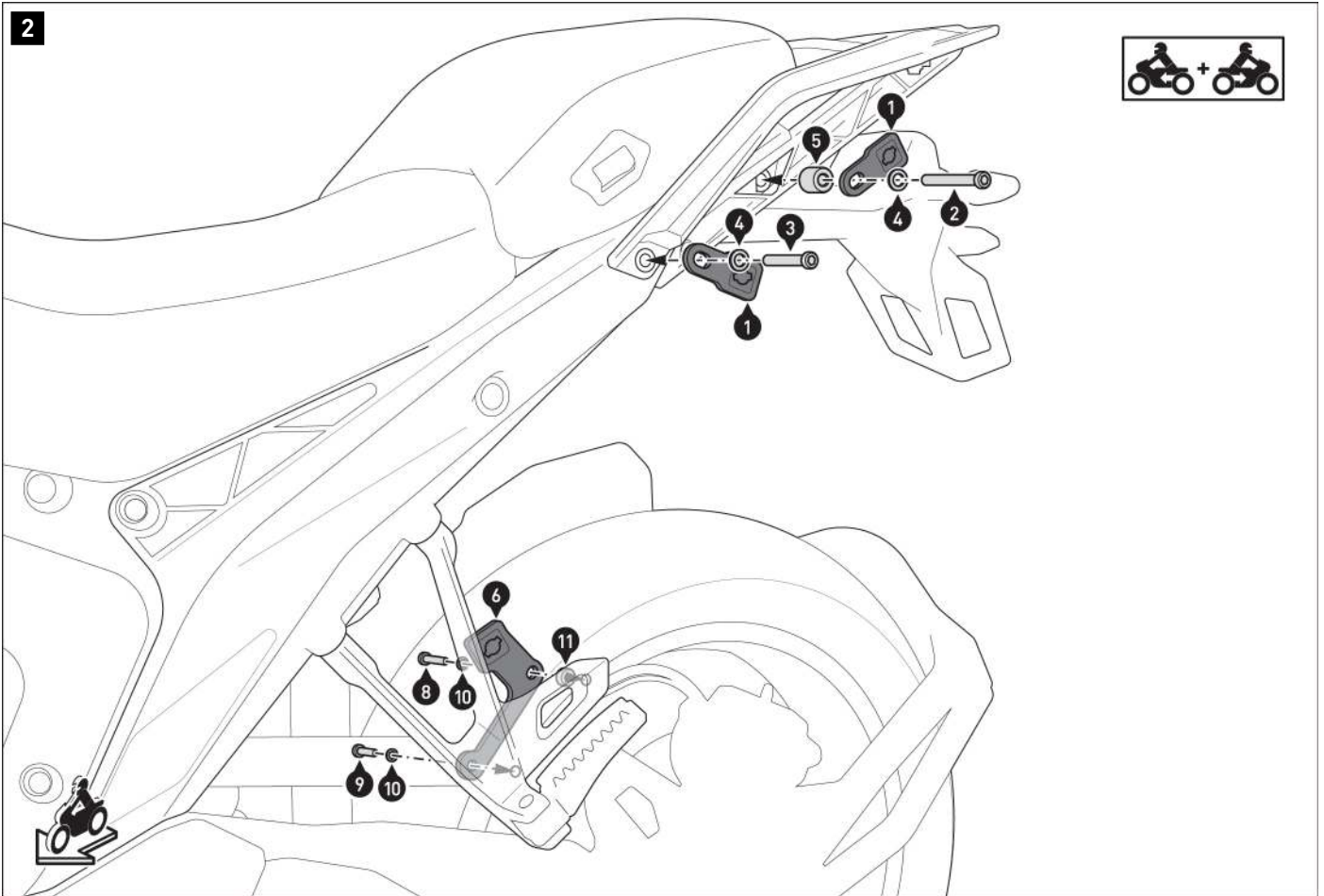

Screw in the fastening straps (1), (6), and (7) on both sides of the vehicle.
▲ WARNING: Use a liquid threadlocker!
 Do not tighten the screws (2), (3), (8) and (9) yet.

1  ×4	8  ×2 M 9.6 Nm	
2  ×2 M OEM	9  ×2 M 9.6 Nm	
3  ×2 M OEM	10  ×4	
4  ×4	11  ×2	
5  ×2		
6  ×1		
7  ×1		

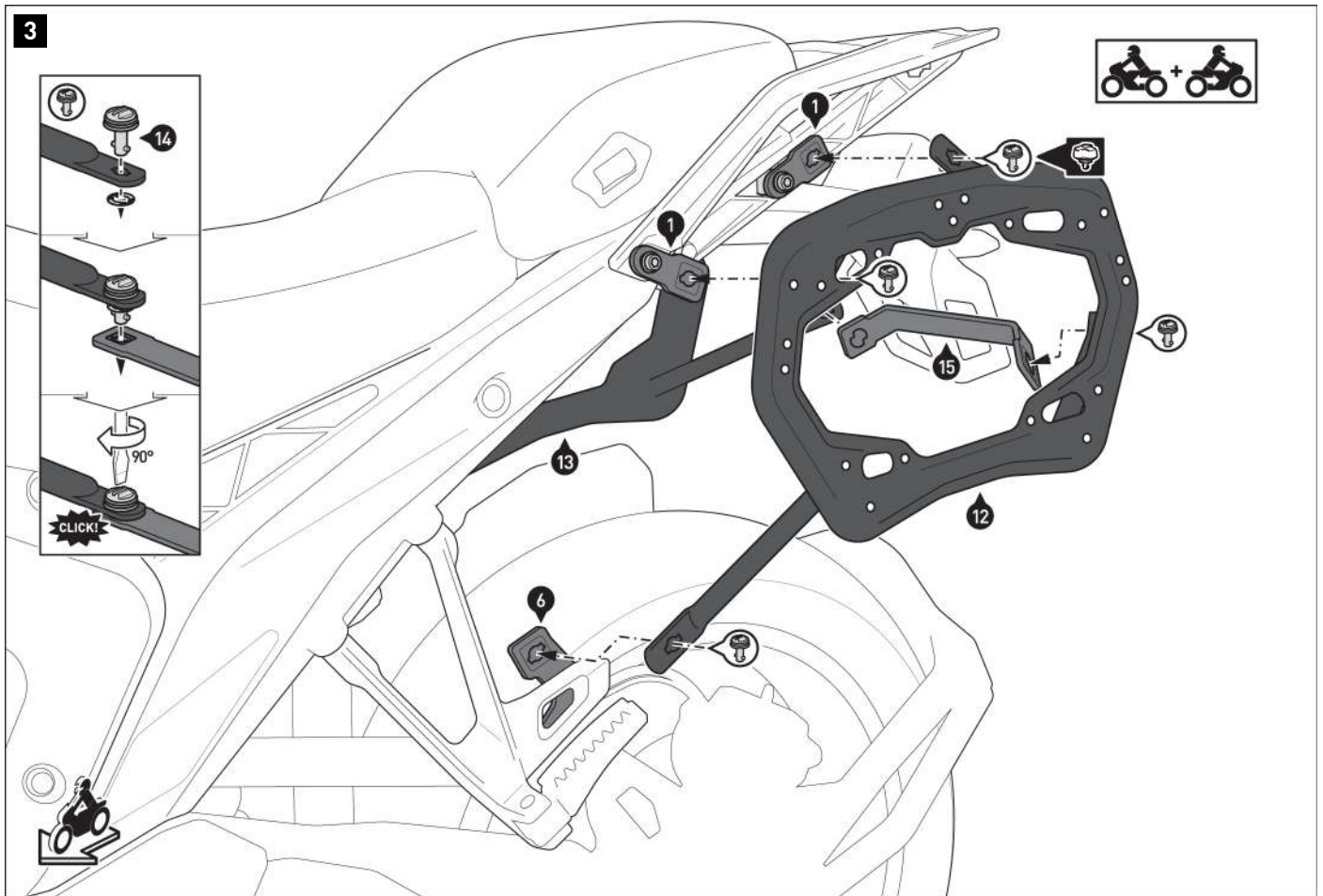

⚠ NOTE: The SW-MOTECH anti-theft protection devices are available separately; mount the anti-theft protection devices on both sides at the indicated position. a

Connect the side carriers (12) and (13) with the quick-release fasteners (14) on the fastening straps (1), (6), and (7) as well as the crossbar (15). Secure the quick-release fasteners using the lock washers.

When all components are in place without tension, tighten the screws (2) and (3) according to the manufacturer's instructions. Tighten the screws (8) and (9) as specified in the mounting instructions.

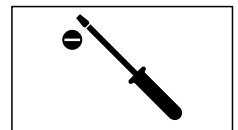
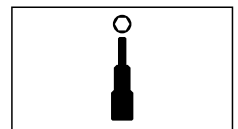

PRODUCT-SPECIFIC NOTES

⚠ DANGER: The specified maximum load includes the weight of the carrier adapter kit/luggage and adapter kit! The maximum vehicle load capacity specified by the vehicle manufacturer is applicable!

 ≤ 12.5KG (≤ 27.5 lbs)  ≤ 130 km/h (≤ 80 mph)

⚠ NOTE: The side carriers have been designed exclusively for use with SW-MOTECH adapter kits.

⚠ NOTE: Dismantle the side carriers when riding without luggage. Always use the side carriers in pairs.

⚠ WARNING: Ensure that the cases are NOT in the exhaust gas flow after mounting them on the vehicle! Risk of burns!

⚠ NOTE: Ensure you adhere to all country-specific regulations regarding the registration and operation of your vehicle as well as the applicable TÜV (German Association for Technical Inspection) regulations. After assembly, parts that are subject to registration should be entered into the vehicle documents by your test center.

Item number: KFT.00.152.36000

Revision: 00 · Date: 08 - 2023

Adapter kit for PRO side carrier

 ~ 0.25 h.

EASY      DIFFICULT

ENGLISH Thank you for choosing this premium product from SW-MOTECH. Visit our online shop for more information (e.g. model assignments). Required documents (e.g. national type approval) are available there for you to download.

Please read and understand all the instructions, safety information and warnings in these mounting instructions before mounting and using the product in order to avoid injury and damage. Keep these mounting instructions for reference.

This product was developed for vehicles in factory condition. Compatibility with original accessories or accessories from other manufacturers cannot be guaranteed.

These mounting instructions have been prepared to the best of our current knowledge. No legal claims relating to accuracy can be made. Errors and omissions excepted. We reserve the right to make technical and design changes. The copyright is held by SW-MOTECH.

SAFETY WARNING SYMBOL

 This warning symbol is used in these mounting instructions to warn of deadly dangers, injuries or other hazards. The words **DANGER**, **WARNING** or **CAUTION** are used as part of this warning symbol to convey important safety messages and information relating to the installation and use of this product. These words, together with the safety warning symbol, mean:

 **DANGER:** Indicates a hazardous situation which, if not avoided, will result in death or serious injury!

 **WARNING:** Indicates a hazardous situation which, if not avoided, may result in death or serious injury!

 **CAUTION:** Indicates a hazardous situation which, if not avoided, may result in minor or moderate injury!

 **NOTE:** Important information, but not relating to a risk of death or injury (property damage only)!

GENERAL INFORMATION

 **WARNING:** Assembly and/or maintenance of this product requires advanced technical skill, appropriate tools, and a good understanding of tool usage and torque specifications. For your own safety, SW-MOTECH recommends having the assembly and/or maintenance carried out by a qualified and certified motorcycle workshop.

 **WARNING:** If you do choose to assemble this product yourself, carefully and fully read the mounting instructions before assembly and use, and follow all instructions to avoid serious injury or death. Also observe all relevant information in the vehicle manual when mounting or using the product. IF YOU DO NOT UNDERSTAND ANY PART OF THESE MOUNTING INSTRUCTIONS OR NEED AN EXPLANATION AS TO A SPECIFIC INSTRUCTION, DO NOT ATTEMPT TO INSTALL THIS PRODUCT WITHOUT CONSULTING SW-MOTECH FOR ASSISTANCE!

PREPARATION: Read the mounting instructions carefully and make sure that all parts on the parts list are available.

 **CAUTION:** Ensure that your vehicle is standing securely. Switch off the engine and remove the ignition key. Allow the engine/exhaust to cool down if necessary. Disconnect the battery when working on the electrical system. Only use proper tools and always wear safety goggles and gloves during assembly and maintenance. Have a second person help you with assembly and maintenance.

ASSEMBLY: All parts and connections removed from the vehicle must be reinstalled according to the vehicle manufacturer's specifications or replaced with parts and hardware supplied by SW-MOTECH.

 **WARNING:** Secure all threads with a medium-strength liquid threadlocker, unless otherwise specified.

 **DANGER:** Tightening torques not defined by SW-MOTECH must be obtained from the vehicle manufacturer or a certified motorbike workshop.



FUNCTIONAL CHECK: After mounting the product, ensure that no moving parts are obstructed and that the function of the vehicle is not impeded. Cables and hoses must not rub against each other and/or be hindered in any way.

 **WARNING:** Carry out a comprehensive functionality check before you start to drive. Check the tightening torque of all connections and the tight fit of the product after the first 50 km and then at regular intervals. Mounted accessories can change the handling and stability of the vehicle.



SW-MOTECH GmbH & Co. KG
Ernteweg 7-10
35282 Rauschenberg
Germany



 info@sw-motech.com
 www.sw-motech.com

LEGEND OVERVIEW - READ AND KEEP MOUNTING INSTRUCTIONS!



Take note of the symbols and what they mean in the ASSEMBLY section. If the term OEM appears in the ASSEMBLY section, the vehicle manufacturer's specifications must be observed and applied.



If you have any questions, please don't hesitate to contact our Customer Service team or our distributors. You can find our telephone number and a list of our distributors in our online shop:

www.sw-motech.com



Do not use thread lock: Indicates that no liquid thread lock should be used at this point.















Tighten/note the tightening torque information:

Indicates the tightening torque of a part specified by SW-MOTECH or the vehicle manufacturer (OEM).



Use thread locker: Indicates that a thread must be coated with liquid thread locker. H (HIGH): high strength; M (MEDIUM): medium strength; L (LOW): low strength.

PARTS LIST - READ AND KEEP MOUNTING INSTRUCTIONS!

<p>1</p> 	<p>2</p> 	<p>3</p> 	<p>4</p> 	<p>5</p> 	<p>6</p> 
<p>HSK.00.745.025.35GR</p> <p> 2/2</p>	<p>M6 x 12; ISO 7380 SC.ST.06.012.02.7380.109</p> <p> 4/4</p>	<p>GPT.00.152.010.35</p> <p> 4/4</p>	<p>M6 x 25; DIN 7991 SC.ST.06.025.02.7991.088</p> <p> 4/4</p>	<p>M6; DIN 6927 MU.ST.06.02.6927.08</p> <p> 4/4</p>	<p>KFT.00.152.026.02</p> <p> 8/8</p>

1

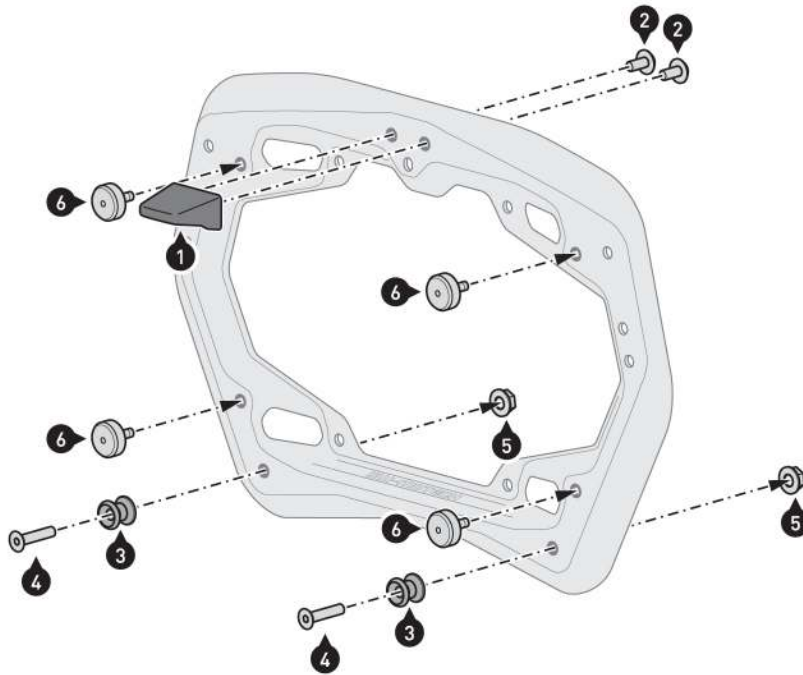

⚠ WARNING: Always wear eye and hand protection!
⚠ WARNING: Always use the proper tools!

⚠ NOTE: The illustration shows how to mount on the right PRO side carrier. Follow the same steps with the left PRO side carrier as with the right PRO side carrier.

Screw the parts indicated to your PRO side carriers (sold separately).

⚠ ATTENTION: Use liquid thread locker (screws 2) only!
 Tighten the screws as specified in the mounting instructions.

Then insert the rubber dampeners (6) into the indicated openings.

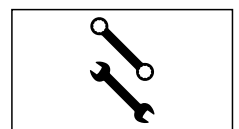
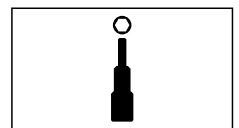
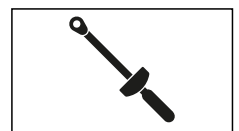
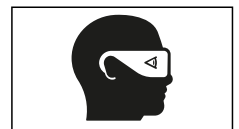

PRODUCT-SPECIFIC NOTES

⚠ NOTE: *Observe the country-specific regulations for the registration/operation of your vehicle or applicable TÜV regulations. After assembly, have parts that are subject to registration entered in the vehicle documents by your test centre.*

Item number: HSK.00.745.11000/B

Revision: 03 · Date: 09 - 2023

DUSC L

 ~ 0.25 h.

EASY      DIFFICULT

ENGLISH Thank you for choosing this premium product from SW-MOTECH. Visit our online shop for more information (e.g. model assignments). Required documents (e.g. national type approval) are available there for you to download.

Please read and understand all the instructions, safety information and warnings in these mounting instructions before mounting and using the product in order to avoid injury and damage. Keep these mounting instructions for reference.

This product was developed for vehicles in factory condition. Compatibility with original accessories or accessories from other manufacturers cannot be guaranteed.

These mounting instructions have been prepared to the best of our current knowledge. No legal claims relating to accuracy can be made. Errors and omissions excepted. We reserve the right to make technical and design changes. The copyright is held by SW-MOTECH.

SAFETY WARNING SYMBOL

 This warning symbol is used in these mounting instructions to warn of deadly dangers, injuries or other hazards. The words **DANGER**, **WARNING** or **CAUTION** are used as part of this warning symbol to convey important safety messages and information relating to the installation and use of this product. These words, together with the safety warning symbol, mean:

 **DANGER:** Indicates a hazardous situation which, if not avoided, will result in death or serious injury!

 **WARNING:** Indicates a hazardous situation which, if not avoided, may result in death or serious injury!

 **CAUTION:** Indicates a hazardous situation which, if not avoided, may result in minor or moderate injury!

 **NOTE:** Important information, but not relating to a risk of death or injury (property damage only)!

GENERAL INFORMATION

 **WARNING:** Assembly and/or maintenance of this product requires advanced technical skill, appropriate tools, and a good understanding of tool usage and torque specifications. For your own safety, SW-MOTECH recommends having the assembly and/or maintenance carried out by a qualified and certified motorcycle workshop.

 **WARNING:** If you do choose to assemble this product yourself, carefully and fully read the mounting instructions before assembly and use, and follow all instructions to avoid serious injury or death. Also observe all relevant information in the vehicle manual when mounting or using the product. IF YOU DO NOT UNDERSTAND ANY PART OF THESE MOUNTING INSTRUCTIONS OR NEED AN EXPLANATION AS TO A SPECIFIC INSTRUCTION, DO NOT ATTEMPT TO INSTALL THIS PRODUCT WITHOUT CONSULTING SW-MOTECH FOR ASSISTANCE!

PREPARATION: Read the mounting instructions carefully and make sure that all parts on the parts list are available.

 **CAUTION:** Ensure that your vehicle is standing securely. Switch off the engine and remove the ignition key. Allow the engine/exhaust to cool down if necessary. Disconnect the battery when working on the electrical system. Only use proper tools and always wear safety goggles and gloves during assembly and maintenance. Have a second person help you with assembly and maintenance.

ASSEMBLY: All parts and connections removed from the vehicle must be reinstalled according to the vehicle manufacturer's specifications or replaced with parts and hardware supplied by SW-MOTECH.

 **WARNING:** Secure all threads with a medium-strength liquid threadlocker, unless otherwise specified.

 **DANGER:** Tightening torques not defined by SW-MOTECH must be obtained from the vehicle manufacturer or a certified motorbike workshop.



FUNCTIONAL CHECK: After mounting the product, ensure that no moving parts are obstructed and that the function of the vehicle is not impeded. Cables and hoses must not rub against each other and/or be hindered in any way.

 **WARNING:** Carry out a comprehensive functionality check before you start to drive. Check the tightening torque of all connections and the tight fit of the product after the first 50 km and then at regular intervals. Mounted accessories can change the handling and stability of the vehicle.



SW-MOTECH GmbH & Co. KG
Ernteweg 7-10
35282 Rauschenberg
Germany



 info@sw-motech.com
 www.sw-motech.com

LEGEND OVERVIEW - READ AND KEEP MOUNTING INSTRUCTIONS!



Take note of the symbols and what they mean in the ASSEMBLY section. If the term OEM appears in the ASSEMBLY section, the vehicle manufacturer's specifications must be observed and applied.



If you have any questions, please don't hesitate to contact our Customer Service team or our distributors. You can find our telephone number and a list of our distributors in our online shop:

www.sw-motech.com



Do not use thread lock: Indicates that no liquid thread lock should be used at this point.



Tighten by hand: Indicates that the attachment must be carefully tightened by hand.

PARTS LIST - READ AND KEEP MOUNTING INSTRUCTIONS!

1

1



HSK.00.745.80000/B

 **1/1**

2

2



HSK.00.745.027.02

 **2/2**

3

3



HSK.00.745.047.02

 **1/1**

4



4 x 10; WN 1452
SC.ST.040.010.48.1452.109

 **2/2**

5



T20
TRX.T20

 **1/1**

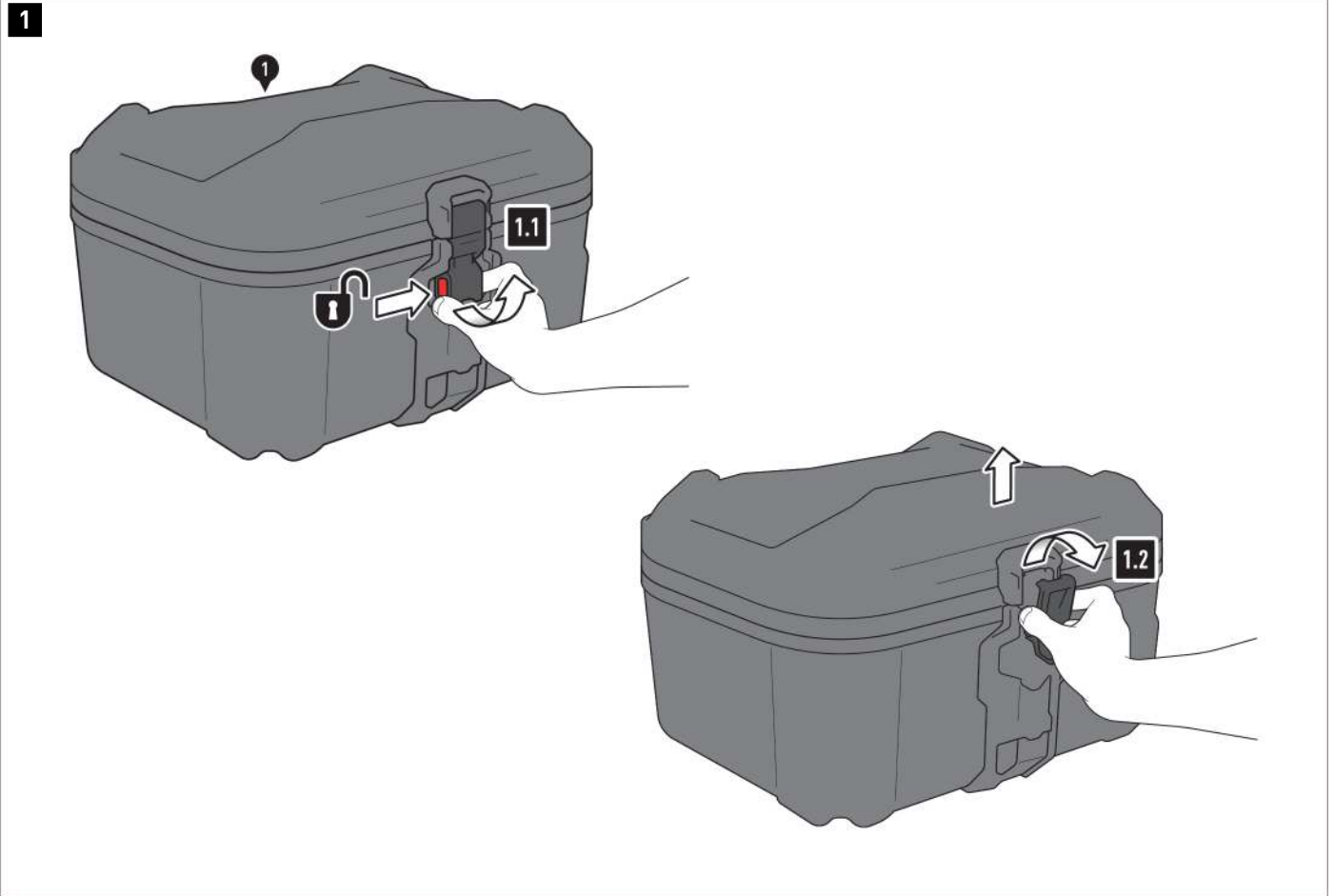

- ⚠ WARNING: Always wear eye and hand protection!
- ⚠ WARNING: Always use the proper tools!

Opening the lid

- 1.1 - Press the DUSC release button (1) and pull the lid latch buckle to the open position.
- 1.2 - Remove the latch buckle from the corresponding bracket and open the lid.

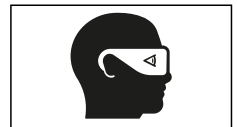

2

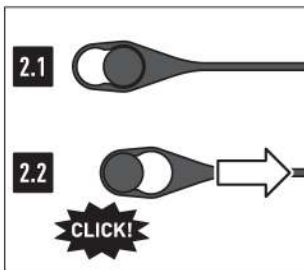
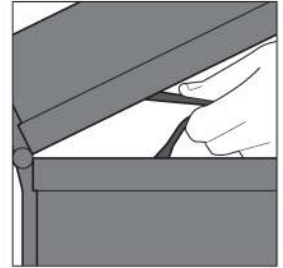
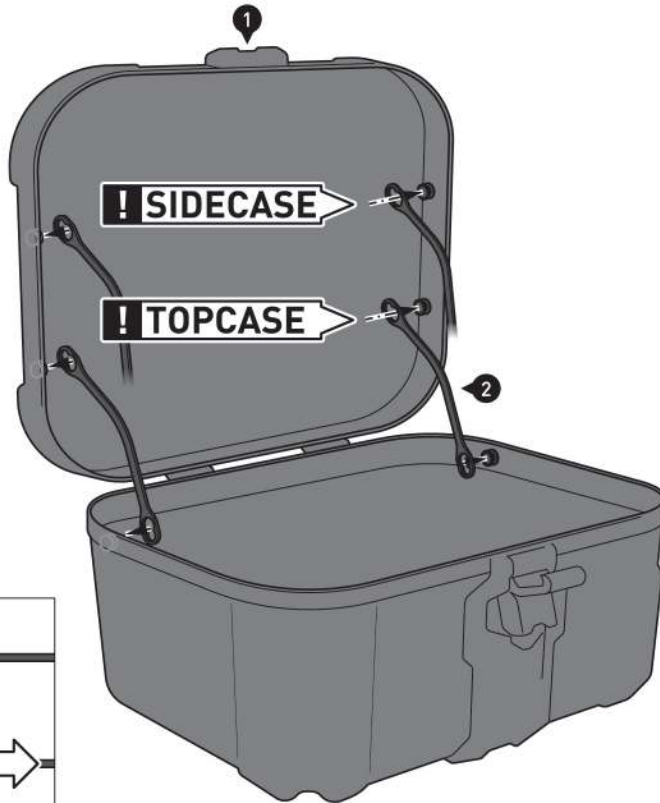

Installing the lid limiter

2.1 - Place the lid limiters (2) with the large openings on the mushroom-shaped supports provided

⚠ NOTE: Pay attention to the proper use of the DUSC (1): **top case** or **side case**. Fasten the lid limiters (2) to the respective mushroom-shaped DUSC (1).

2.2 - Pull the lid limiters (2) into fixed position.

⚠ NOTE: Before closing the lid for the first time, the lid limiters (2) must be slightly compressed. When closing the lid, make sure that the lid limiters (2) are not trapped between the lid and the case body.

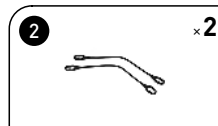

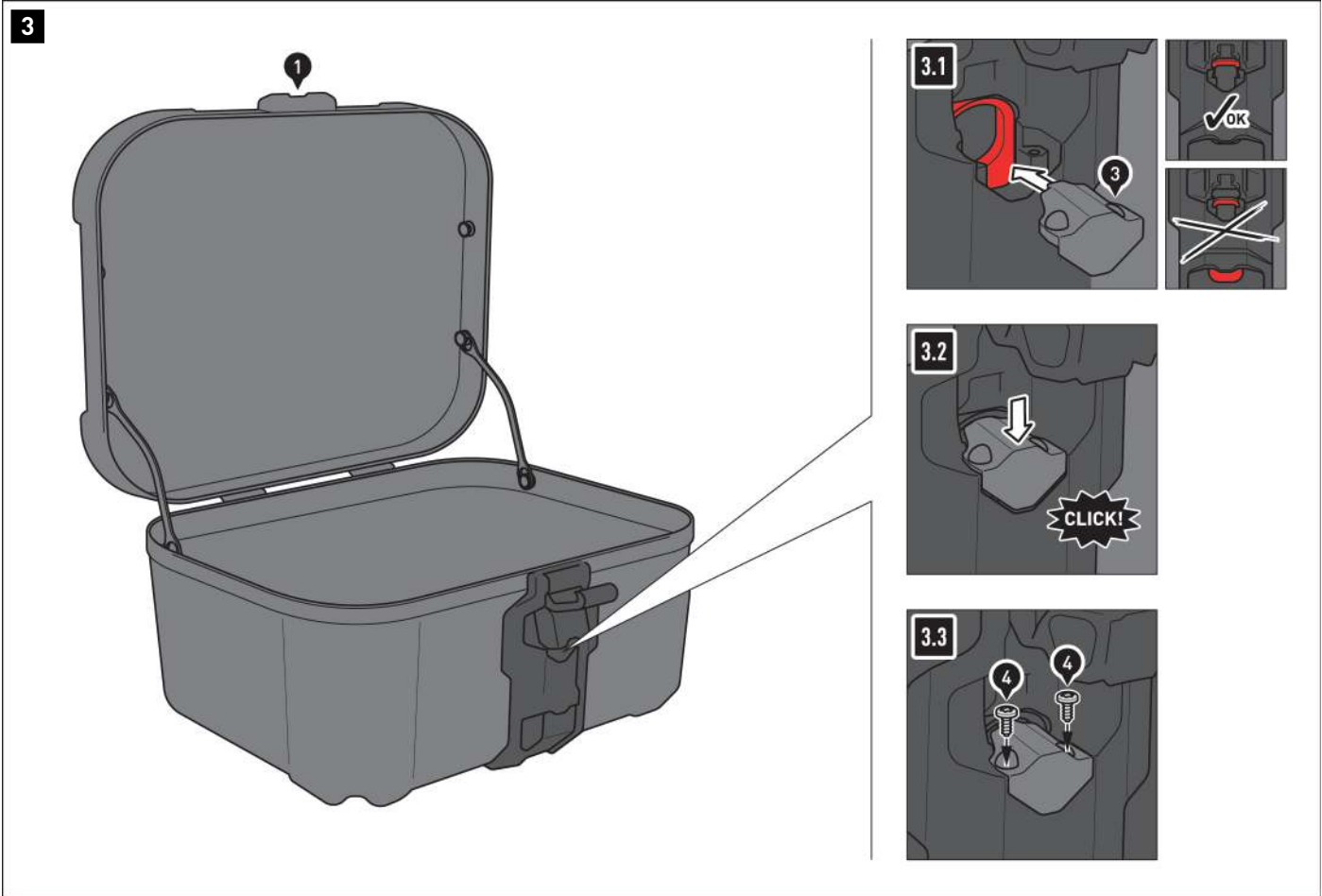

Installing lock casing connector

⚠ NOTE: If you have opted for the DUSC lock set, this step is not necessary. Install the lock set instead.

3.1 - Open the DUSC latch buckle (1) and position the latch housing connector (3) as shown.

⚠ NOTE: Make sure the locking tab is in the unlocked (up) position. If necessary, the locking tab must be pushed up into the unlocked position.

3.2 - Push the latch housing connector (3) down until it clicks into place.

3.3 - Screw in the latch housing connector (3) using the screws (4) and the torx key (5). Carefully tighten the screws by hand.

⚠ WARNING: Over-tightening the screws may damage the lock casing!

⚠ NOTE: Ensure that the locking mechanism is in working order!

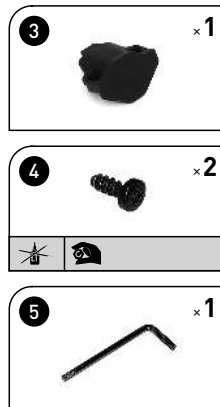

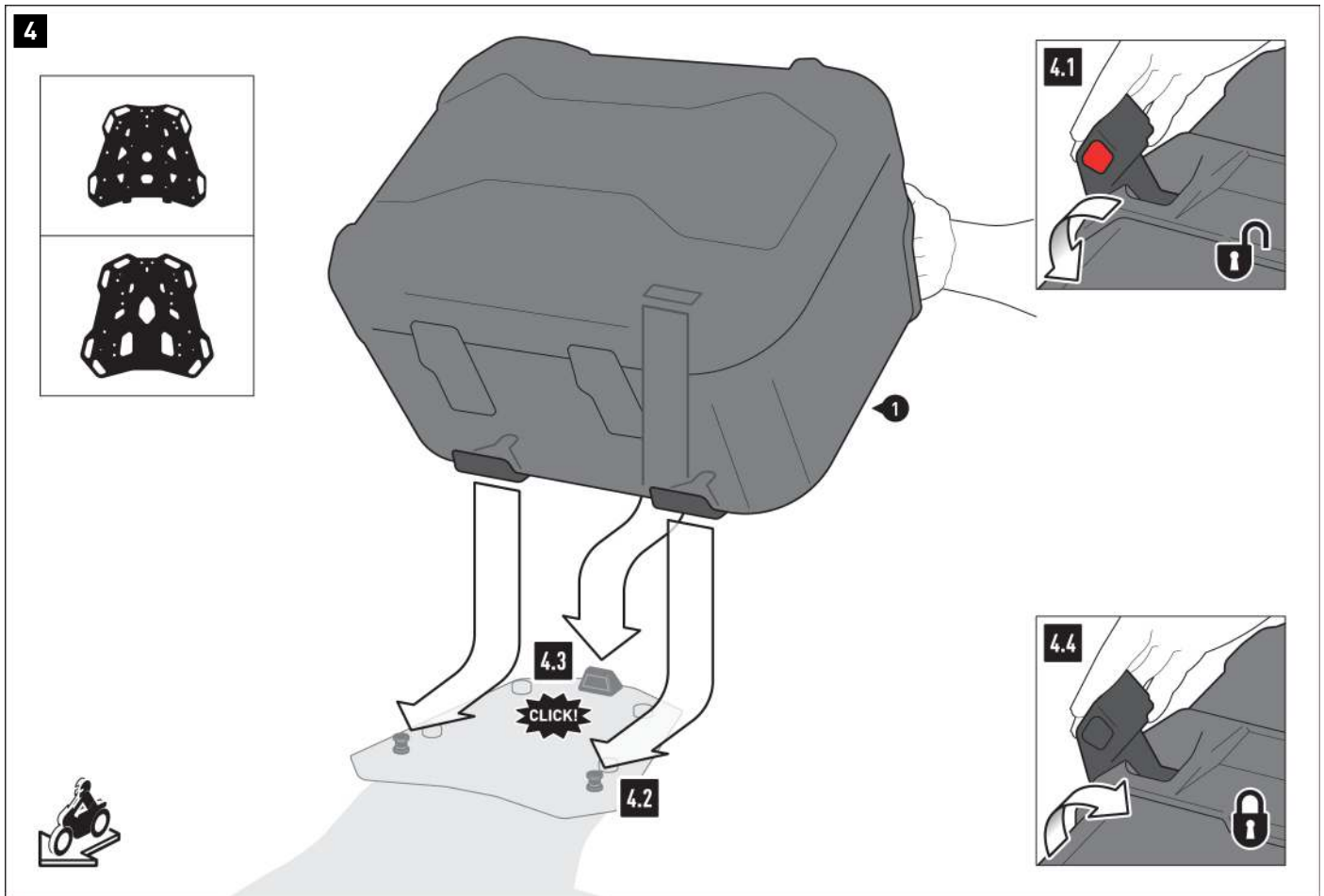

Attaching the DUSC to a top case

4.1 - Press the DUSC release button (1) and pull the fastening system latch buckle to the open position.

4.2 - Press the DUSC (1) with the two locking openings onto the mushroom-shaped supports of your SW-MOTECH rack.

4.3 - Press the DUSC (1) with the locking opening onto the locking lug of your SW-MOTECH rack.

▲ WARNING: You should be able to hear a clicking sound!

4.4 - Press the system latch buckle to closed position.

▲ WARNING: Ensure the DUSC is firmly positioned!

▲ WARNING: Make sure that no components of the DUSC (1) can come into contact with any hot and moving parts on the vehicle!

Also ensure that all components are at least 5 cm away from hot parts as well as hot gas coming from the exhaust!

After assembly, make sure that this distance is maintained in all vehicle positions!

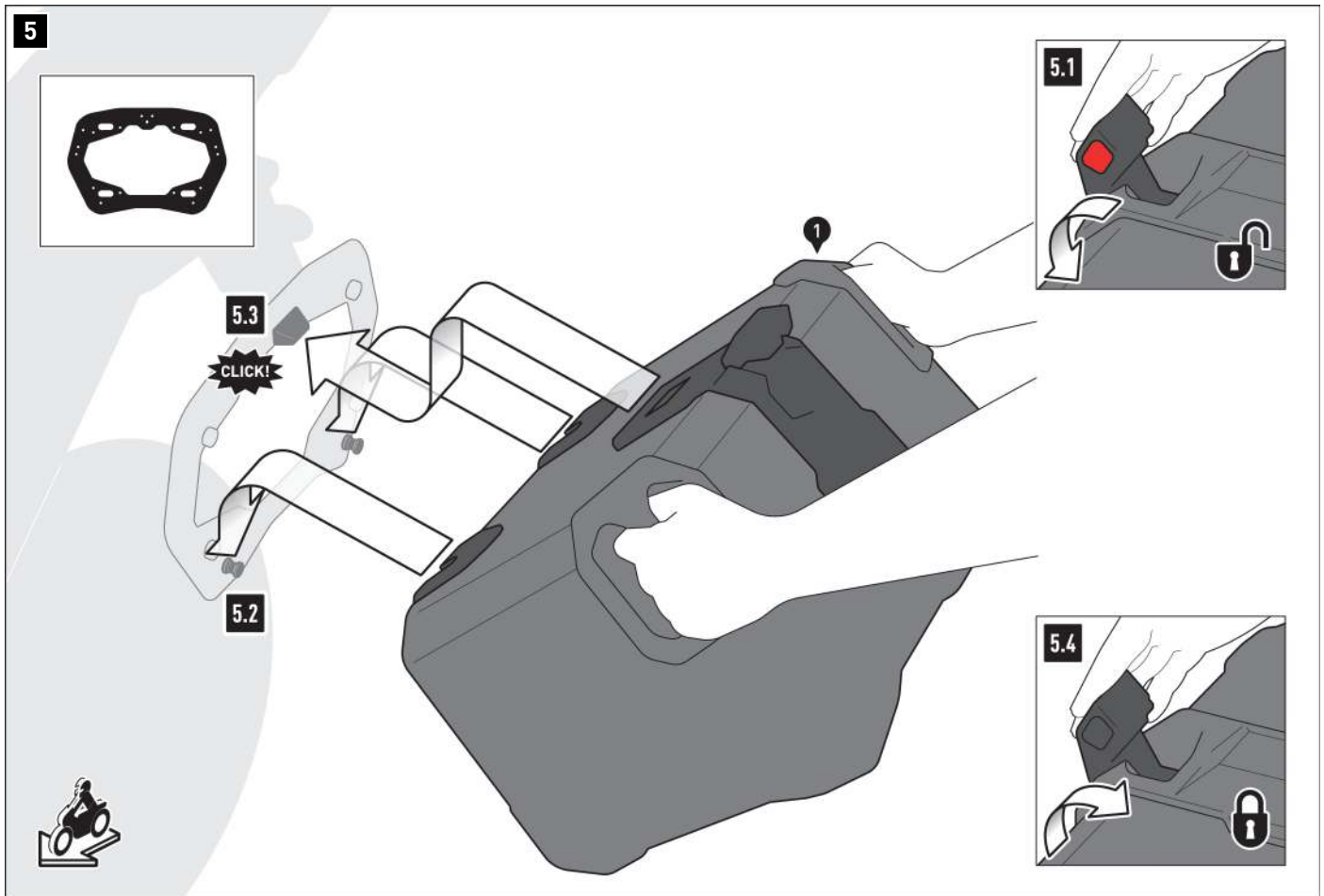

Attaching the DUSC to a side case

5.1 - Press the DUSC release button (1) and pull the system latch buckle to the open position.

5.2 - Press the DUSC (1) with the two locking openings onto the mushroom-shaped supports of your SW-MOTECH side carrier.

5.3 - Press the DUSC (1) with the locking opening onto the locking lug of your SW-MOTECH side carrier.

▲ WARNING: You should be able to hear a clicking sound!

5.4 - Press the system latch buckle to closed position.

▲ WARNING: Ensure the DUSC is firmly positioned!

▲ WARNING: Make sure that no components of the DUSC (1) can come into contact with any hot and moving parts on the vehicle!

Also ensure that all components are at least 5 cm away from hot parts as well as hot gas coming from the exhaust!

After assembly, make sure that this distance is maintained in all vehicle positions!

6

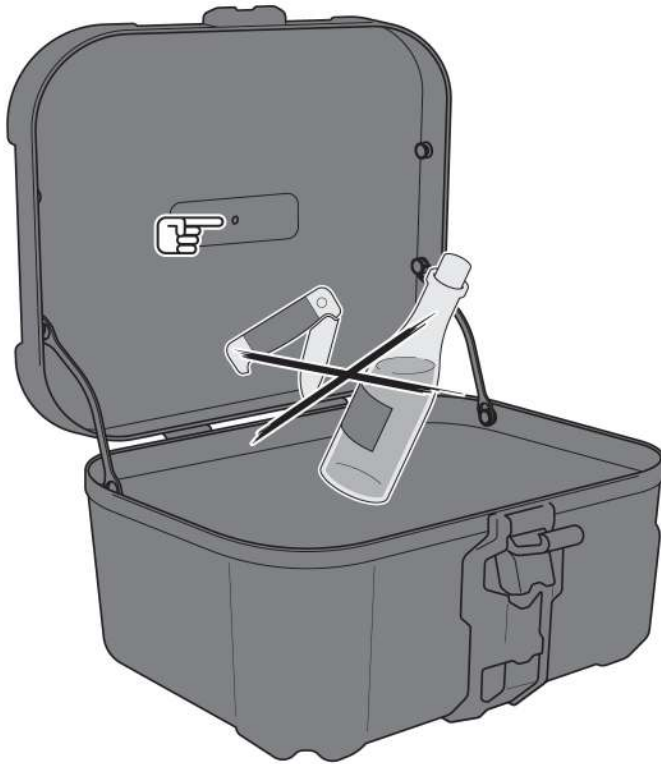

Loading

⚠ WARNING: Ensure that the load is evenly distributed! Ensure that the load will not slip while driving!

⚠ NOTE: Make sure never to store sharp-edged, pointed or similar objects that could cause personal injury or damage to the vehicle/DUSC! Be particularly careful not to damage the overpressure membrane built into the lid!

Care

Use ONLY a soft textile brush, cloth or sponge and warm soapy water for cleaning! Then rinse with clean water.

Do NOT use any harsh cleaning agents, utensils or pressure washer! Be sure to clean the DUSC after winter driving to avoid salt damage.

⚠ NOTE: Surface materials may be subject to fluctuations in color (fading) in the event of prolonged and intensive exposure to sunlight and the elements (e.g. smog, acid rain, etc.)! SW-MOTECH is not responsible for this type of wear!

PRODUCT-SPECIFIC NOTES

⚠ NOTE: Observe the country-specific regulations for registering/operating your vehicle or the applicable TÜV regulations. After assembly, have parts that are subject to registration entered in the vehicle documents by your test centre.

⚠ DANGER: Carry out a comprehensive function check before driving!

⚠ DANGER: Check that the product is properly positioned before departure and at every rest stop (every 200 km)!

⚠ DANGER: The driving/braking behavior of the motorcycle changes noticeably after the attachment of this product!

⚠ DANGER: Lean angle and ground clearance may be restricted by this product!

⚠ DANGER: The maximum vehicle load defined by the vehicle manufacturer may NOT be exceeded.

The maximum permissible load of the SW-MOTECH rack/side rack may NOT be exceeded; make sure to take into account the dead weight of the product.

Dead weight of DUSC M: 3.9 kg (8.6 lbs)

Dead weight of DUSC L: 4.1 kg (9 lbs)

Payload when used as a top case:

 ≤ 5 kg (≤ 11 lbs)	 ≤ 130km/h (≤ 80mph)
---	---

Payload when used as a side case:

 ≤ 10KG (≤ 22 lbs)	 ≤ 130km/h (≤ 80mph)
---	---

Item number: **LOC.00.745.10200**

Revision: **00** · Date: **08 - 2023**

Hard case lock set

 ~ 0.25 h.

EASY      DIFFICULT

ENGLISH Thank you for choosing this premium product from SW-MOTECH. Visit our online shop for more information (e.g. model assignments). Required documents (e.g. national type approval) are available there for you to download.

Please read and understand all the instructions, safety information and warnings in these mounting instructions before mounting and using the product in order to avoid injury and damage. Keep these mounting instructions for reference.

This product was developed for vehicles in factory condition. Compatibility with original accessories or accessories from other manufacturers cannot be guaranteed.

These mounting instructions have been prepared to the best of our current knowledge. No legal claims relating to accuracy can be made. Errors and omissions excepted. We reserve the right to make technical and design changes. The copyright is held by SW-MOTECH.

SAFETY WARNING SYMBOL

 This warning symbol is used in these mounting instructions to warn of deadly dangers, injuries or other hazards. The words **DANGER**, **WARNING** or **CAUTION** are used as part of this warning symbol to convey important safety messages and information relating to the installation and use of this product. These words, together with the safety warning symbol, mean:

 **DANGER:** Indicates a hazardous situation which, if not avoided, will result in death or serious injury!

 **WARNING:** Indicates a hazardous situation which, if not avoided, may result in death or serious injury!

 **CAUTION:** Indicates a hazardous situation which, if not avoided, may result in minor or moderate injury!

 **NOTE:** Important information, but not relating to a risk of death or injury (property damage only)!

GENERAL INFORMATION

 **WARNING:** Assembly and/or maintenance of this product requires advanced technical skill, appropriate tools, and a good understanding of tool usage and torque specifications. For your own safety, SW-MOTECH recommends having the assembly and/or maintenance carried out by a qualified and certified motorcycle workshop.

 **WARNING:** If you do choose to assemble this product yourself, carefully and fully read the mounting instructions before assembly and use, and follow all instructions to avoid serious injury or death. Also observe all relevant information in the vehicle manual when mounting or using the product. IF YOU DO NOT UNDERSTAND ANY PART OF THESE MOUNTING INSTRUCTIONS OR NEED AN EXPLANATION AS TO A SPECIFIC INSTRUCTION, DO NOT ATTEMPT TO INSTALL THIS PRODUCT WITHOUT CONSULTING SW-MOTECH FOR ASSISTANCE!

PREPARATION: Read the mounting instructions carefully and make sure that all parts on the parts list are available.

 **CAUTION:** Ensure that your vehicle is standing securely. Switch off the engine and remove the ignition key. Allow the engine/exhaust to cool down if necessary. Disconnect the battery when working on the electrical system. Only use proper tools and always wear safety goggles and gloves during assembly and maintenance. Have a second person help you with assembly and maintenance.

ASSEMBLY: All parts and connections removed from the vehicle must be reinstalled according to the vehicle manufacturer's specifications or replaced with parts and hardware supplied by SW-MOTECH.

 **WARNING:** Secure all threads with a medium-strength liquid threadlocker, unless otherwise specified.

 **DANGER:** Tightening torques not defined by SW-MOTECH must be obtained from the vehicle manufacturer or a certified motorbike workshop.



FUNCTIONAL CHECK: After mounting the product, ensure that no moving parts are obstructed and that the function of the vehicle is not impeded. Cables and hoses must not rub against each other and/or be hindered in any way.

 **WARNING:** Carry out a comprehensive functionality check before you start to drive. Check the tightening torque of all connections and the tight fit of the product after the first 50 km and then at regular intervals. Mounted accessories can change the handling and stability of the vehicle.



SW-MOTECH GmbH & Co. KG
Ernteweg 7-10
35282 Rauschenberg
Germany



 info@sw-motech.com
 www.sw-motech.com



Take note of the symbols and what they mean in the ASSEMBLY section. If the term OEM appears in the ASSEMBLY section, the vehicle manufacturer's specifications must be observed and applied.



If you have any questions, please don't hesitate to contact our Customer Service team or our distributors. You can find our telephone number and a list of our distributors in our online shop:

www.sw-motech.com

PARTS LIST - READ AND KEEP MOUNTING INSTRUCTIONS!

2

1



HSK.00.745.500.04

 **3/3**

2



T20
TRX.T20

 **1/1**

3



ALK.00.165.A63

 **2/2**

3

3



ALK.00.165.562.01

 **1/1**

4

5



QLS.00.095.520.01

 **2/2**

6



SV.ST.095.007.LK.02

 **2/2**

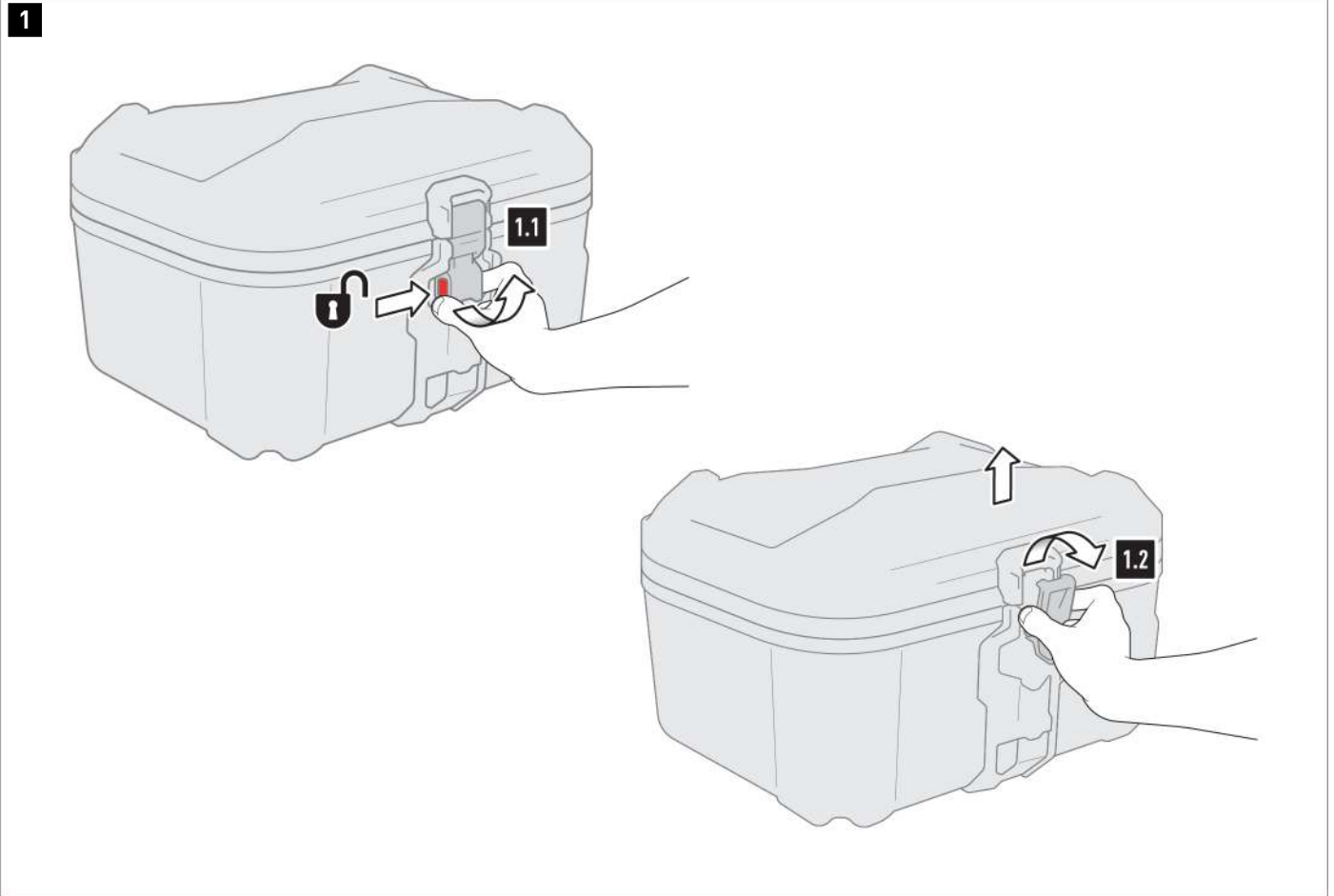

- ⚠ **WARNING: Always wear eye and hand protection!**
- ⚠ **WARNING: Always use the proper tools!**

Opening the lid

1.1 - Press the DUSC release button (*) and pull the lid latch buckle into the open position.

1.2 - Remove the latch buckle from the corresponding bracket and open the lid.

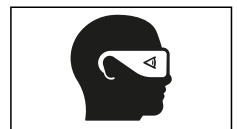

2

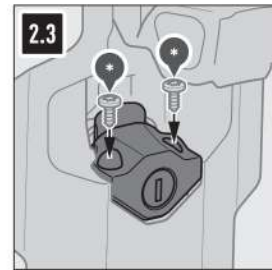
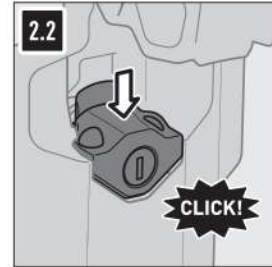
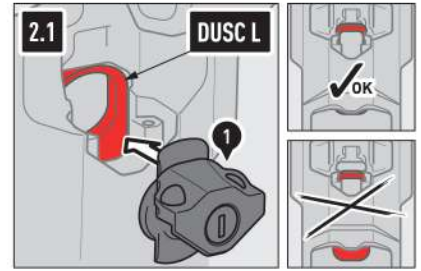

Install DUSC lock

2.1 - Open the DUSC (*) latch buckle and position the lock (1) as shown.
 ⚠ **NOTE: DUSC L ONLY:** Make sure the locking tab (highlighted in red) is in the unlocked position (up)! If necessary, the locking tab must be pushed up into the unlocked position!

2.2 - Push the lock (1) down until it clicks into place.

2.3 - Screw in the lock (1) using the screws (*) supplied with the DUSC and the torx key (2). Carefully tighten the screws by hand.

⚠ **WARNING: Over-tightening the screws may damage the lock casing!**

⚠ **NOTE:** Ensure that the locking mechanism is in working order!

⚠ **NOTE:** NEVER lubricate the lock cylinder with oil! Only use graphite powder!



3

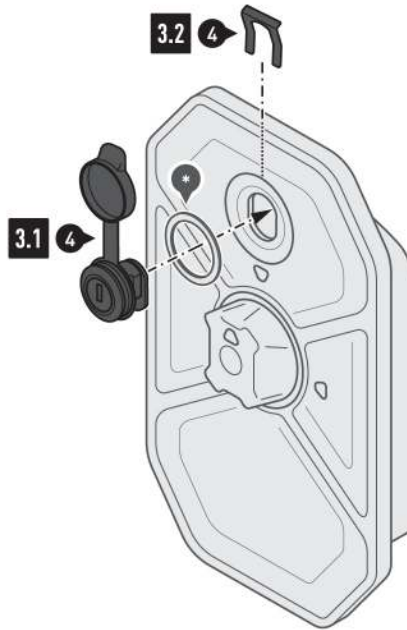

Install toolbox lock

3.1 - Insert the lock (4) with the sealing ring (*) supplied with the toolbox in the lock hole of the cover. Secure the lock (4) on the inside with the safety clip (4)



⚠ NOTE: NEVER lubricate the lock cylinder with oil! Only use graphite powder!

4

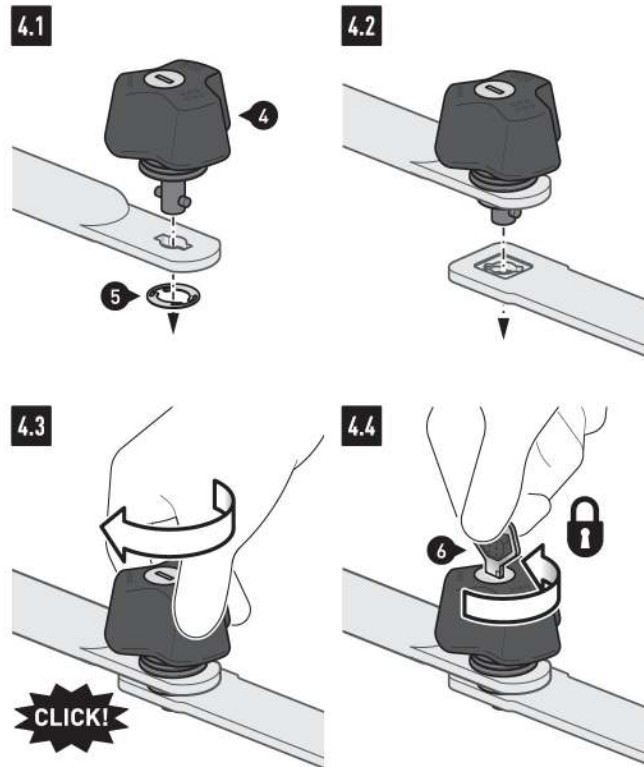

Mount anti-theft protection device for PRO side carrier

4.1 - Insert the anti-theft protection device (5) into the side carrier opening defined in the side carrier mounting instructions. Secure the anti-theft protection device (5) with the lock washer (6).

4.2 - Now insert the anti-theft protection device (5) in the opening of the side support fastener ...

4.3 - ... and turn the anti-theft protection device (5) until it engages.

4.4 - Then the anti-theft protection device (5) must be secured against unscrewing.

⚠ NOTE: NEVER lubricate the lock cylinder with oil! Only use graphite powder!



PRODUCT-SPECIFIC NOTES

⚠ NOTE: *Observe the country-specific regulations for the registration/operation of your vehicle or applicable TÜV regulations. After assembly, have parts that are subject to registration entered in the vehicle documents by your test centre.*