

# ANBAUANLEITUNG

mounting instructions • instructions de montage • instrucciones de montaje • istruzioni di montaggio

## **GPT.02.059.65000/B**

beinhaltet • contains • contient • contiene • contiene

GPT.02.059.19000/B

GPT.00.152.36200/B

HSK.00.745.11000/B

LOC.00.745.10000

Art.-Nr.: GPT.02.059.19000/B

Revision: 00 · Datum: 08 - 2023

## ADVENTURE-RACK Gepäckträger

 ~ 0.5 h.LEICHT     SCHWER

**DEUTSCH** - Vielen Dank, dass Sie sich für dieses Premium-Produkt von SW-MOTECH entschieden haben. Besuchen Sie unseren Webshop für weitere Informationen (z. B. Modellzuweisungen). Erforderliche Dokumente (z. B. ABE) stehen Ihnen dort als Download zur Verfügung.

Bitte lesen und verstehen Sie alle Anweisungen, Sicherheitshinweise und Warnungen in dieser Anbauanleitung vor Montage und Nutzung des Produkts, um Verletzungen und Schäden zu vermeiden. Bewahren Sie diese Anbauanleitung als Referenz auf.

Dieses Produkt wurde für Fahrzeuge im Werkzustand entwickelt. Die Kompatibilität mit Original-Zubehörteilen bzw. den Zubehörteilen anderer Hersteller kann nicht gewährleistet werden.

Diese Anbauanleitung ist nach unserem derzeitigen Kenntnisstand verfasst worden. Rechtliche Ansprüche auf Richtigkeit bestehen nicht. Fehler und Irrtümer vorbehalten. Technische und gestalterische Änderungen sind vorbehalten. Das Urheberrecht liegt bei SW-MOTECH.

## SICHERHEITSWARNUNGSSYMBOL

 Dieses Warnsymbol wird in dieser Anbauanleitung verwendet, um vor tödlichen Gefahren, Verletzungen oder anderen Gefahren zu warnen. Die Wörter **GEFAHR**, **WARNUNG** oder **VORSICHT** werden mit diesem Warnsymbol verwendet, um wichtige Sicherheitshinweise und Informationen in Bezug auf die Montage und Nutzung dieses Produkts zu übermitteln. Diese Wörter zusammen mit dem Sicherheitswarnsymbol bedeuten:

**GEFAHR:** Weist auf eine gefährliche Situation hin, die zum Tod oder zu schweren Verletzungen führt, wenn sie nicht vermieden wird!

**WARNUNG:** Weist auf eine gefährliche Situation hin, die zum Tod oder zu schweren Verletzungen führen kann, wenn sie nicht vermieden wird!

**VORSICHT:** Weist auf eine gefährliche Situation hin, die zu leichten oder mittelschweren Verletzungen führen kann, wenn sie nicht vermieden wird!

**HINWEIS:** Wichtige Informationen, jedoch nicht in Bezug auf Todes- oder Verletzungsgefahr (nur Sachschäden)!

## ALLGEMEINE HINWEISE

**WARNUNG:** Die Montage und/oder Wartung dieses Produkts erfordert fortgeschrittene technische Fähigkeiten, geeignetes Werkzeug und ein gutes Verständnis der Werkzeugnutzung und Drehmomentangaben. Zu Ihrer eigenen Sicherheit empfiehlt SW-MOTECH, die Montage und/oder Wartung von einer qualifizierten und zertifizierten Zweiradwerkstatt durchführen zu lassen.

**WARNUNG:** Wenn Sie sich für die Eigenmontage dieses Produkts entscheiden, lesen Sie vor Montage und Nutzung die Anbauanleitung sorgfältig und vollständig durch und befolgen Sie alle Anweisungen, um schwere oder tödliche Verletzungen zu vermeiden. Beachten Sie bei der Montage und Verwendung auch alle relevanten Informationen im Fahrzeughandbuch. **WENN SIE EINEN TEIL DIESER ANBAUANLEITUNG NICHT VERSTEHEN ODER EINE ERKLÄRUNG EINER ANWEISUNG BENÖTIGEN, VERSUCHEN SIE NICHT DIESES PRODUKT ZU MONTIEREN, OHNE SW-MOTECH UM HILFE ZU FRAGEN!**

**VORBEREITUNG:** Lesen Sie die Anbauanleitung aufmerksam und stellen Sie sicher, dass alle Teile der Stückliste vorhanden sind.

**VORSICHT:** Achten Sie auf den sicheren Stand Ihres Fahrzeugs. Schalten Sie den Motor ab und ziehen Sie den Zündschlüssel. Lassen Sie den Motor/Auspuff bei Bedarf abkühlen. Klemmen Sie die Batterie bei Arbeiten an der Elektrik ab. Verwenden Sie nur geeignetes Werkzeug und tragen Sie während der Montage und Wartung immer eine Schutzbrille und Handschuhe. Lassen Sie sich bei der Montage und Wartung von einer zweiten Person helfen.

**MONTAGE:** Alle vom Fahrzeug entfernten Teile und Verbindungen müssen gemäß den Angaben des Fahrzeugherstellers wieder eingebaut oder durch von SW-MOTECH gelieferte Teile und Hardware ersetzt werden.

**WARNUNG:** Sichern Sie alle Gewinde, sofern nicht anders angegeben, mit mittelstarker, flüssiger Schraubensicherung.

**GEFAHR:** Von SW-MOTECH nicht definierte Anzugsdrehmomente müssen Sie vom Fahrzeughersteller oder von einer zertifizierten Motorradwerkstatt beziehen.

**FUNKTIONSKONTROLLE:** Stellen Sie nach der Montage sicher, dass keine beweglichen Teile blockiert sind und die Funktion des Fahrzeugs nicht gestört wird. Kabel und Schläuche dürfen nicht scheuern und/oder geklemmt werden.

**WARNUNG:** Führen Sie vor Fahrtbeginn eine umfassende Funktionskontrolle durch. Prüfen Sie nach den ersten 50 km und dann regelmäßig das Anzugsmoment aller Verbindungen und den festen Sitz des Produkts. Montiertes Zubehör kann das Fahrverhalten und die Stabilität des Fahrzeugs verändern.



SW-MOTECH GmbH & Co. KG  
Ernteweg 7-10  
35282 Rauschenberg  
Deutschland



info@sw-motech.com  
www.sw-motech.com



Beachten Sie in dem Abschnitt MONTAGE vorkommenden Symbole und deren Bedeutung. Wenn im Abschnitt MONTAGE die Bezeichnung OEM vorkommt, müssten die Vorgaben des Fahrzeugherstellers beachtet und angewandt werden.



Bei Fragen steht Ihnen unser Kundendienst sowie unsere Distributoren gerne zur Verfügung. Unsere Telefonnummer sowie eine Liste unserer Distributoren finden Sie in unserem Webshop: [www.sw-motech.com](http://www.sw-motech.com)



**Schraubensicherung verwenden:** Weist darauf hin, dass ein Gewinde mit flüssiger Schraubensicherung bestrichen werden muss. H (HIGH): hohe Festigkeit; M (MEDIUM): mittlere Festigkeit; L (LOW): niedrige Festigkeit.



**Anziehen / Anzugsmomentangabe beachten:** Weist auf das von SW-MOTECH bzw. vom Fahrzeughersteller (OEM) vorgegebene Anzugsmoment eines Teils hin.

STÜCKLISTE - ANBAUANLEITUNG LESEN UND AUFBEWAHREN!

1

1



GPT.02.059.001.11

 1/1

2



M6 x 20; DIN 7991  
SC.ST.06.020.48.7991.109

 4/4

3



∅ 20 / ∅ 6,4 / h 8  
DB.ST.0200.0064.0080.02

 4/4

2

4



GPT.00.152.002.11

 1/1

5



M6 x 16; ISO 7380  
SC.ST.06.016.02.7380.109

 4/4

6



∅ 6,4; DIN 9021  
US.ST.064.02.9021

 4/4

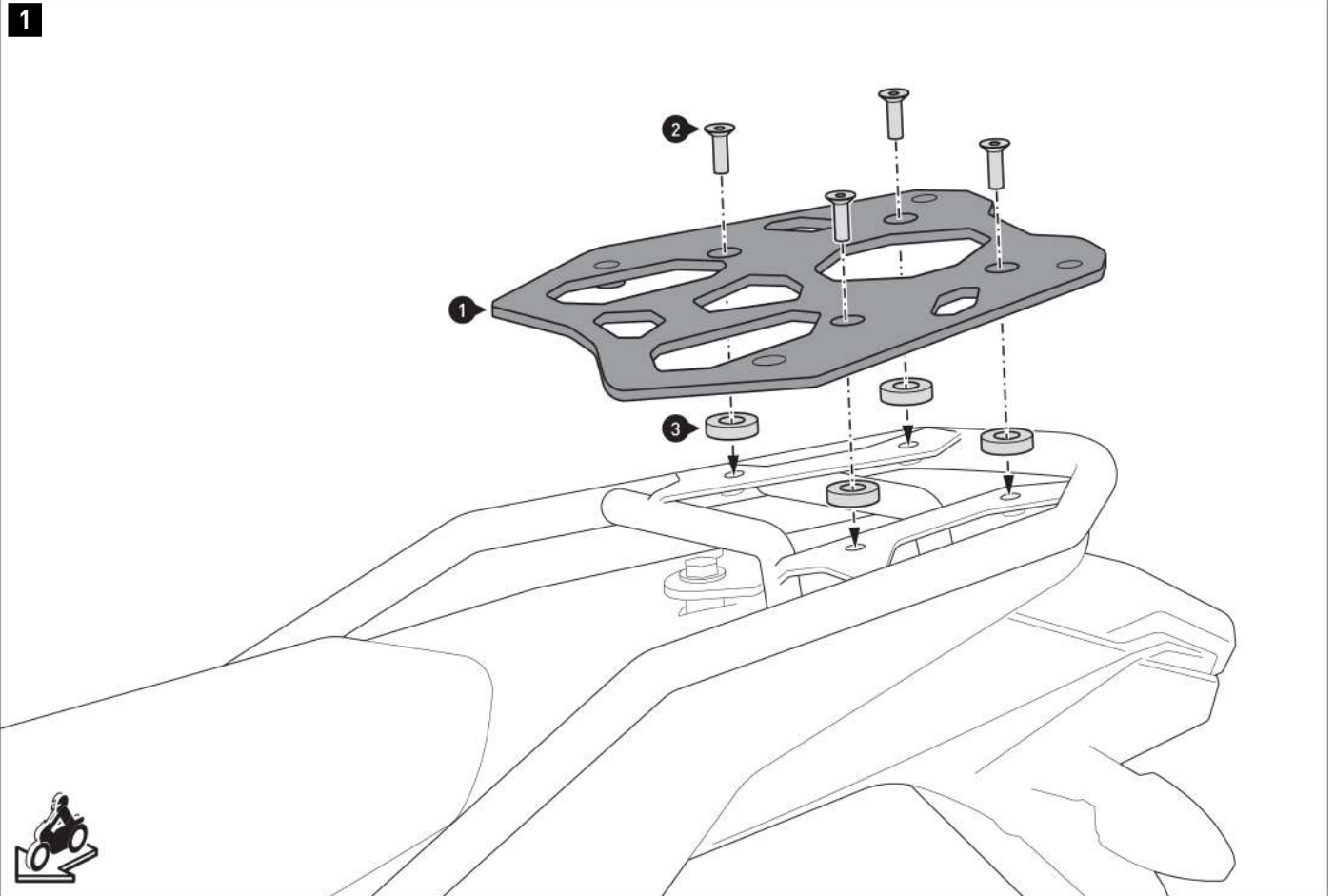

- ▲ **WARNUNG:** Tragen Sie immer Augen- und Handschutz!
- ▲ **WARNUNG:** Verwenden Sie immer geeignetes Werkzeug!

Montieren Sie das Anbaublech (1) auf dem Gepäckträger.  
 ▲ **WARNUNG:** Verwenden Sie flüssige Schraubensicherung!  
 Ziehen Sie die Schrauben wie in der Anbauanleitung vorgegeben an.

<b>1</b>		x1
<b>2</b>		x4
	<b>M</b>	<b>9,6 Nm</b>
<b>3</b>		x4

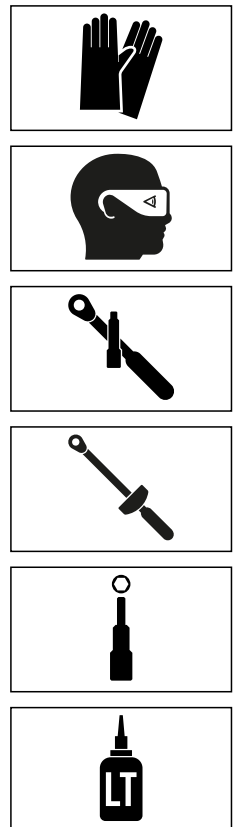

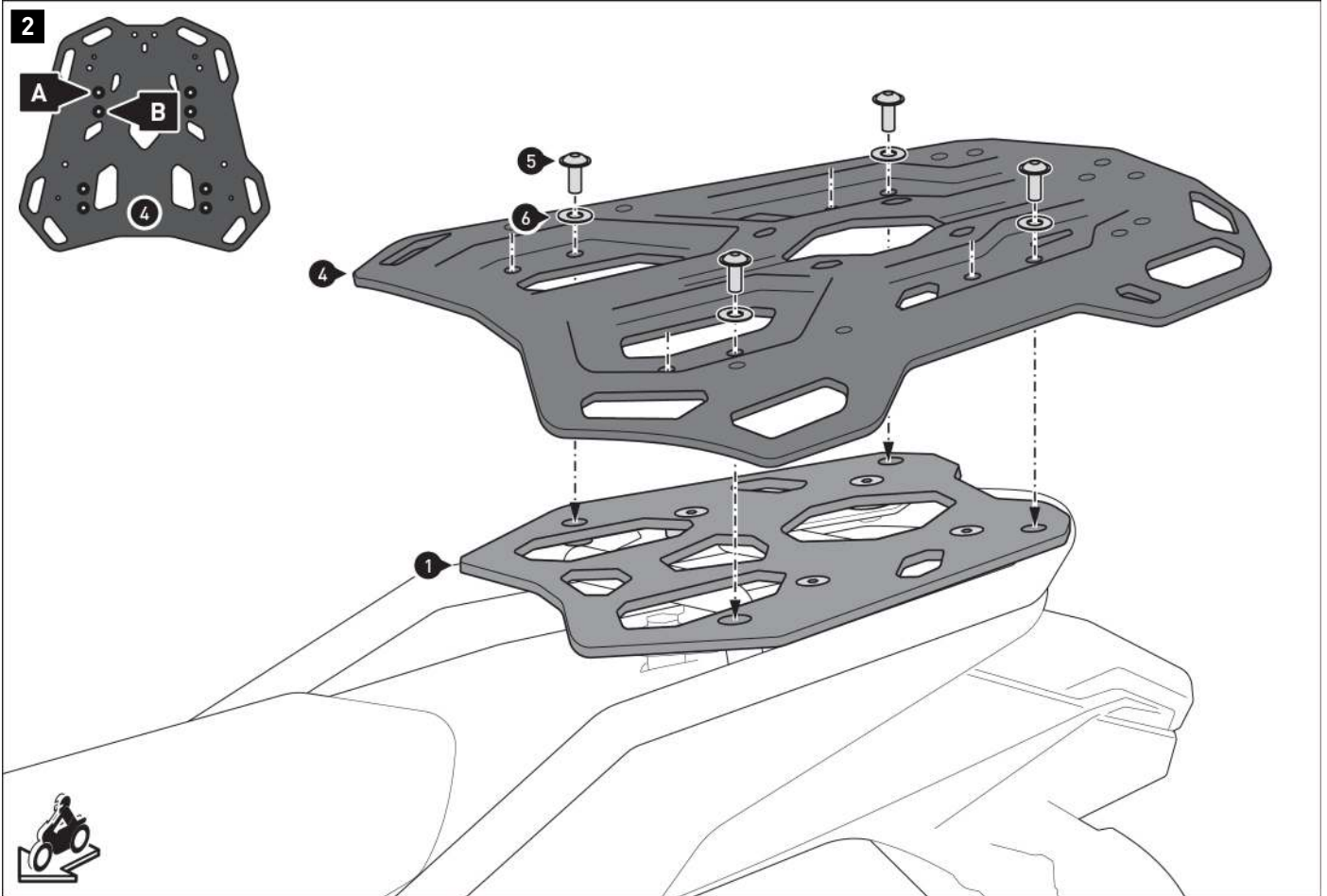

**⚠ HINWEIS:** Verschrauben Sie den Gepäckträger je nach Platzangebot an der markierten Anbauposition (A) oder (B), wie in der Detailzeichnung gezeigt.

Montieren Sie den Gepäckträger (4) auf dem Anbaublech (1).

**⚠ WARNUNG: Verwenden Sie flüssige Schraubensicherung!**

Ziehen Sie die Schrauben wie in der Anbauanleitung vorgegeben an.

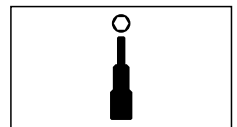
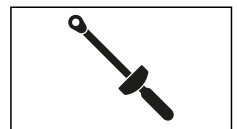

PRODUKTSPEZIFISCHE HINWEISE

**⚠ WARNUNG:** Die angegebene maximale Zuladung beinhaltet das Gewicht von Koffer/Gepäck und Adapterplatte/Adapterkit! Es gilt die vom Fahrzeughersteller genannte, maximale Zuladung des Fahrzeugs!

 ≤ 7,5 KG (≤ 16,5 lbs) |  ≤ 130 km/h (≤ 80mph)

**⚠ HINWEIS:** Beachten Sie alle landesspezifischen Vorschriften für Zulassung und Betrieb Ihres Fahrzeugs sowie anwendbare TÜV-Vorschriften. Lassen Sie eintragungspflichtige Teile nach Montage durch Ihre Prüfstelle in die Fahrzeugpapiere eintragen.

Item number: GPT.02.059.19000/B

Revision: 00 · Date: 08 - 2023

## ADVENTURE RACK

 ~ 0.5 h.EASY      DIFFICULT

**ENGLISH** Thank you for choosing this premium product from SW-MOTECH. Visit our online shop for more information (e.g. model assignments). Required documents (e.g. national type approval) are available there for you to download.

Please read and understand all the instructions, safety information and warnings in these mounting instructions before mounting and using the product in order to avoid injury and damage. Keep these mounting instructions for reference.

This product was developed for vehicles in factory condition. Compatibility with original accessories or accessories from other manufacturers cannot be guaranteed.

These mounting instructions have been prepared to the best of our current knowledge. No legal claims relating to accuracy can be made. Errors and omissions excepted. We reserve the right to make technical and design changes. The copyright is held by SW-MOTECH.

## SAFETY WARNING SYMBOL

 This warning symbol is used in these mounting instructions to warn of deadly dangers, injuries or other hazards. The words DANGER, WARNING or CAUTION are used as part of this warning symbol to convey important safety messages and information relating to the installation and use of this product. These words, together with the safety warning symbol, mean:

 **DANGER:** Indicates a hazardous situation which, if not avoided, will result in death or serious injury!

 **WARNING:** Indicates a hazardous situation which, if not avoided, may result in death or serious injury!

 **CAUTION:** Indicates a hazardous situation which, if not avoided, may result in minor or moderate injury!

 **NOTE:** Important information, but not relating to a risk of death or injury (property damage only)!

## GENERAL INFORMATION

 **WARNING:** Assembly and/or maintenance of this product requires advanced technical skill, appropriate tools, and a good understanding of tool usage and torque specifications. For your own safety, SW-MOTECH recommends having the assembly and/or maintenance carried out by a qualified and certified motorcycle workshop.

 **WARNING:** If you do choose to assemble this product yourself, carefully and fully read the mounting instructions before assembly and use, and follow all instructions to avoid serious injury or death. Also observe all relevant information in the vehicle manual when mounting or using the product. IF YOU DO NOT UNDERSTAND ANY PART OF THESE MOUNTING INSTRUCTIONS OR NEED AN EXPLANATION AS TO A SPECIFIC INSTRUCTION, DO NOT ATTEMPT TO INSTALL THIS PRODUCT WITHOUT CONSULTING SW-MOTECH FOR ASSISTANCE!

**PREPARATION:** Read the mounting instructions carefully and make sure that all parts on the parts list are available.

 **CAUTION:** Ensure that your vehicle is standing securely. Switch off the engine and remove the ignition key. Allow the engine/exhaust to cool down if necessary. Disconnect the battery when working on the electrical system. Only use proper tools and always wear safety goggles and gloves during assembly and maintenance. Have a second person help you with assembly and maintenance.

**ASSEMBLY:** All parts and connections removed from the vehicle must be reinstalled according to the vehicle manufacturer's specifications or replaced with parts and hardware supplied by SW-MOTECH.

 **WARNING:** Secure all threads with a medium-strength liquid threadlocker, unless otherwise specified.

 **DANGER:** Tightening torques not defined by SW-MOTECH must be obtained from the vehicle manufacturer or a certified motorbike workshop.

**FUNCTIONAL CHECK:** After mounting the product, ensure that no moving parts are obstructed and that the function of the vehicle is not impeded. Cables and hoses must not rub against each other and/or be hindered in any way.

 **WARNING:** Carry out a comprehensive functionality check before you start to drive. Check the tightening torque of all connections and the tight fit of the product after the first 50 km and then at regular intervals. Mounted accessories can change the handling and stability of the vehicle.



SW-MOTECH GmbH & Co. KG  
Ernteweg 7-10  
35282 Rauschenberg  
Germany



 [info@sw-motech.com](mailto:info@sw-motech.com)  
 [www.sw-motech.com](http://www.sw-motech.com)





Take note of the symbols and what they mean in the ASSEMBLY section. If the term OEM appears in the ASSEMBLY section, the vehicle manufacturer's specifications must be observed and applied.



If you have any questions, please don't hesitate to contact our Customer Service team or our distributors. You can find our telephone number and a list of our distributors in our online shop:

**[www.sw-motech.com](http://www.sw-motech.com)**



**Use thread locker:** Indicates that a thread must be coated with liquid thread locker. H (HIGH): high strength; M (MEDIUM): medium strength; L (LOW): low strength.



**Tighten/note the tightening torque information:**

Indicates the tightening torque of a part specified by SW-MOTECH or the vehicle manufacturer (OEM).

**PARTS LIST - READ AND KEEP MOUNTING INSTRUCTIONS!**

**1**

**1**



GPT.02.059.001.11

 1/1

**2**



M6 x 20; DIN 7991  
SC.ST.06.020.48.7991.109

 4/4

**3**



∅ 20 / ∅ 6,4 / h 8  
DB.ST.0200.0064.0080.02

 4/4

**2**

**4**



GPT.00.152.002.11

 1/1

**5**



M6 x 16; ISO 7380  
SC.ST.06.016.02.7380.109

 4/4

**6**



∅ 6.4; DIN 9021  
US.ST.064.02.9021

 4/4

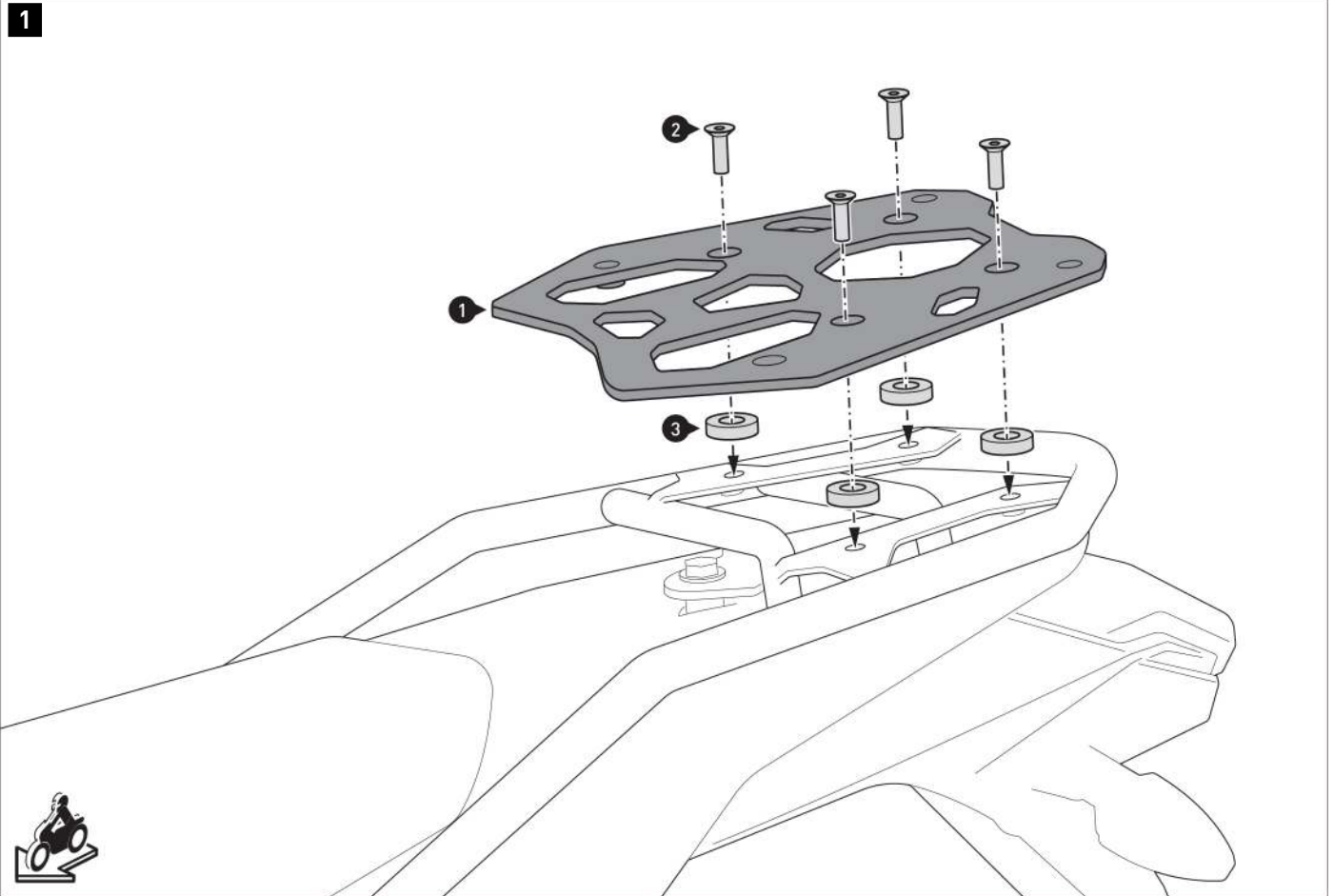

**▲ WARNING: Always wear eye and hand protection!**  
**▲ WARNING: Always use the proper tools!**

Mount the mounting bracket (1) on the rack.

**▲ WARNING: Use a liquid threadlocker!**  
 Tighten the screws as specified in the mounting instructions.

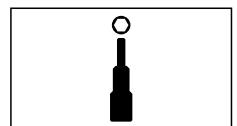
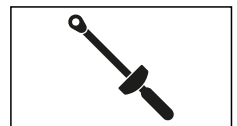
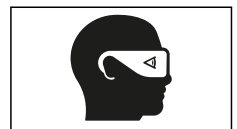

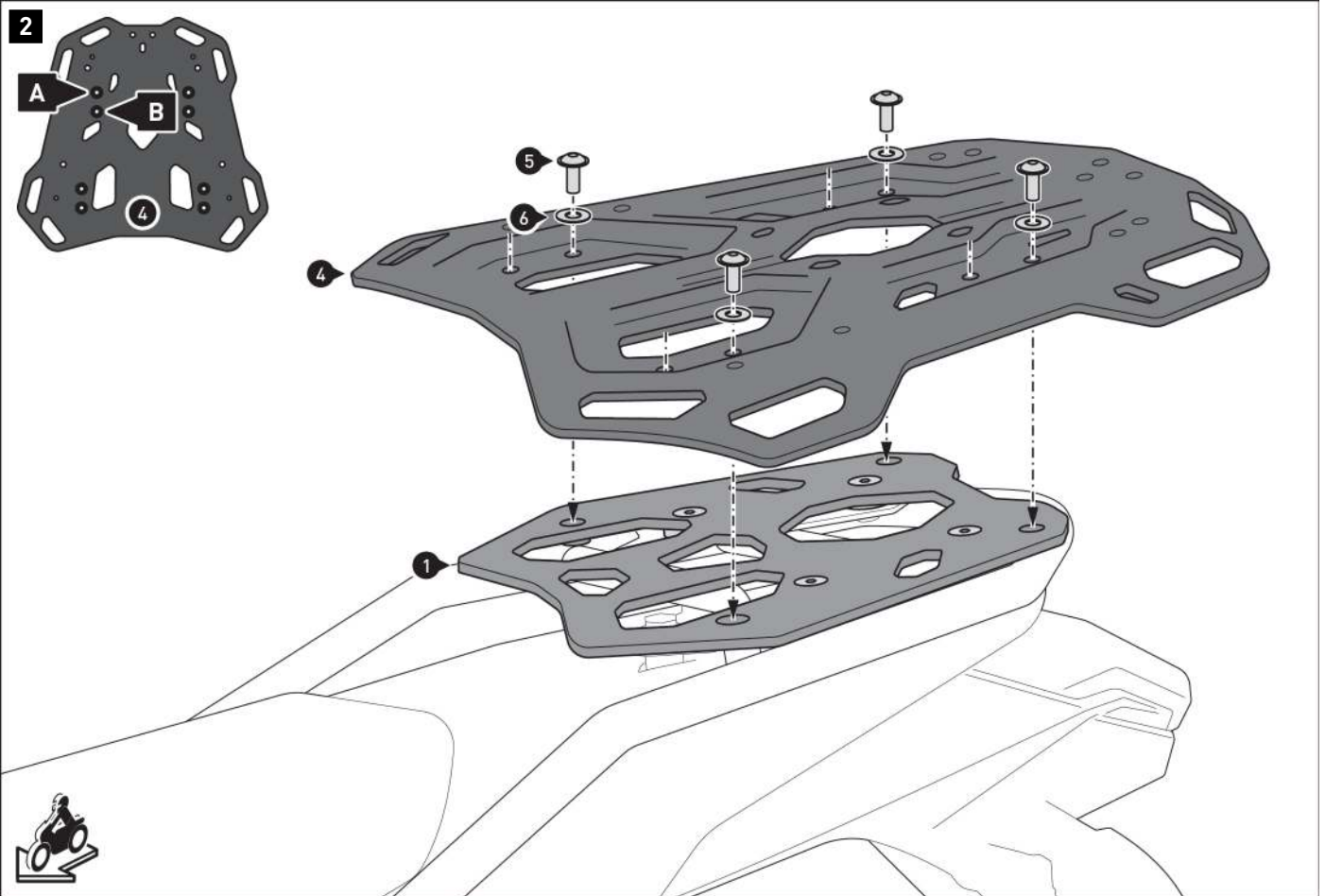

**⚠ NOTE:** Depending on the space available, screw the luggage rack to the marked attachment position (A) or (B) as shown in the detailed drawing.

Mount the luggage rack (4) on the mounting plate (1).

**⚠ WARNING: Use a liquid threadlocker!**

Tighten the screws as specified in the mounting instructions.

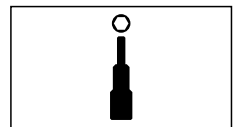
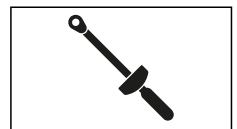

PRODUCT-SPECIFIC NOTES

**⚠ WARNING:** The specified maximum load includes the weight of the case/luggage and adapter plate/adapter kit! The maximum vehicle load specified by the vehicle manufacturer applies!



≤ 7.5KG (≤ 16.5 lbs)



≤ 130 km/h (≤ 80 mph)

**⚠ NOTE:** Ensure you adhere to country-specific regulations regarding the registration and operation of your vehicle or any applicable TÜV regulations. After assembly, parts that are subject to registration should be entered in the vehicle documents by your test center.

Número de artículo: GPT.02.059.19000/B

Revisión: 00 · Fecha: 08 - 2023

## Portaequipaje ADVENTURE RACK

 ~ 0.5 h.

 FÁCIL     COMPLICADO

**ESPAÑOL** · Gracias por elegir este producto de primera calidad de SW-MOTECH. Visite nuestra tienda online para obtener más información (p. ej., sobre el uso de los modelos). Desde esa página podrá descargar los documentos que necesite (por ejemplo, la homologación nacional de tipo).

Para evitar lesiones y daños, asegúrese de leer y comprender todas las instrucciones, advertencias de seguridad y precauciones de este manual antes de montar y utilizar el producto. Guarde estas instrucciones de montaje como referencia.

Este producto ha sido desarrollado para vehículos en condiciones de fábrica. No se garantiza la compatibilidad con los accesorios originales o de otros fabricantes.

Estas instrucciones de montaje se han redactado de acuerdo con nuestros conocimientos actuales. No hay reclamaciones legales de corrección. Salvo errores y omisiones. Nos reservamos el derecho a realizar cambios técnicos y de diseño. Los derechos de autor pertenecen a SW-MOTECH.

### SÍMBOLO DE ADVERTENCIA DE SEGURIDAD

 Este símbolo de advertencia se utiliza en estas instrucciones de montaje para advertir de peligros mortales, lesiones u otros riesgos. Las palabras PELIGRO, ATENCIÓN o PRECAUCIÓN se utilizan con este símbolo de advertencia para transmitir importantes avisos de seguridad e información relacionada con el montaje y uso de este producto. Estas palabras, junto con el símbolo de advertencia de seguridad, significan:

 **PELIGRO:** Indica una situación de peligro que, si no se evita, provoca lesiones graves o incluso la muerte.

 **ATENCIÓN:** Indica una situación de peligro que, si no se evita, puede provocar lesiones graves o incluso la muerte.

 **PRECAUCIÓN:** Indica una situación de peligro que, si no se evita, puede provocar lesiones leves o de gravedad media.

 **NOTA:** Información importante, pero que no está relacionada con un riesgo de lesiones o muerte (solo daños materiales).

### INDICACIONES GENERALES

 **ATENCIÓN:** El montaje y/o mantenimiento de este producto requiere conocimientos técnicos avanzados, las herramientas apropiadas, un buen manejo de dichas herramientas y conocer las especificaciones de los pares de apriete. Por su propia seguridad, SW-MOTECH recomienda que el montaje y/o el mantenimiento los realice un taller de motocicletas cualificado y certificado.

 **ATENCIÓN:** Si elige ensamblar este producto usted mismo, antes de montarlo y usarlo, lea las instrucciones de montaje detenidamente y en su totalidad, y siga todas las indicaciones para evitar lesiones graves o mortales. Cuando monte y utilice el producto, tenga también en cuenta toda la información relevante que figure en el manual del vehículo. SI NO ENTIENDE ALGUNA PARTE DE ESTAS INSTRUCCIONES DE MONTAJE O NECESITA ALGUNA ACLARACIÓN, NO INTENTE INSTALAR ESTE PRODUCTO SIN CONSULTAR A SW-MOTECH PARA OBTENER AYUDA.

**PREPARACIÓN:** Lea atentamente las instrucciones de montaje y asegúrese de que todas las piezas de la lista de piezas están presentes.

 **PRECAUCIÓN:** Asegúrese de que su vehículo esté estacionado de manera segura. Apague el motor y retire la llave de encendido. Deje que el motor o el escape se enfrien si es necesario. Desconecte la batería cuando trabaje en el sistema eléctrico. Utilice únicamente las herramientas adecuadas y use siempre gafas de seguridad y guantes al realizar el montaje y las tareas de mantenimiento. Pida a otra persona que le ayude con el montaje y el mantenimiento.

**MONTAJE:** Todas las piezas y conexiones retiradas del vehículo deben ser reinstaladas de acuerdo con las especificaciones del fabricante del vehículo o sustituidas por piezas y herrajes suministrados por SW-MOTECH.

 **ATENCIÓN:** Asegure todas las roscas con fijador de roscas líquido de resistencia media, a menos que se especifique lo contrario.

 **PELIGRO:** Los pares de apriete no definidos por SW-MOTECH deben obtenerse del fabricante del vehículo o de un taller de motocicletas certificado.

**COMPROBACIÓN FUNCIONAL:** Después del montaje, asegúrese de que no haya piezas móviles bloqueadas y de que no se altere el funcionamiento del vehículo. Los cables y tubos no deben rozarse ni quedar pinzados.

 **ATENCIÓN:** Realice una comprobación exhaustiva del funcionamiento antes de iniciar la marcha. Tras los primeros 50 km y, después, con regularidad, compruebe el par de apriete de todas las conexiones y que el producto está firmemente sujeto. Los accesorios instalados pueden cambiar el comportamiento de conducción y la estabilidad del vehículo.



SW-MOTECH GmbH & Co. KG  
Ernteweg 7-10  
35282 Rauschenberg  
Alemania



✉ info@sw-motech.com  
🌐 www.sw-motech.com



Preste atención a los símbolos que figuran en la sección de MONTAJE y su significado. Cuando, en la sección de MONTAJE, aparecen las siglas OEM, se deberán seguir y aplicar las especificaciones del fabricante del vehículo.



Si tiene alguna pregunta, nuestro servicio de atención al cliente y nuestros distribuidores estarán encantados de prestarle ayuda. Encontrará nuestro número de teléfono y una lista de nuestros distribuidores en nuestra tienda online:

[www.sw-motech.com](http://www.sw-motech.com)



**Usar fijador de roscas:** Indica que una rosca debe recubrirse con fijador de roscas líquido. H (HIGH): resistencia alta; M (MEDIUM): resistencia media; L (LOW): resistencia baja.



**Respete la información del par de apriete:** Indica el par de apriete de una pieza especificada por SW-MOTECH o el fabricante del vehículo (OEM).

LISTA DE PIEZAS - LEE Y CONSERVA LAS INSTRUCCIONES DE MONTAJE!

1

1



GPT.02.059.001.11

 1/1

2



M6 x 20; DIN 7991  
SC.ST.06.020.48.7991.109

 4/4

3



∅ 20 / ∅ 6,4 / h 8  
DB.ST.0200.0064.0080.02

 4/4

2

4



GPT.00.152.002.11

 1/1

5



M6 x 16; ISO 7380  
SC.ST.06.016.02.7380.109

 4/4

6



∅ 6,4; DIN 9021  
US.ST.064.02.9021

 4/4



1

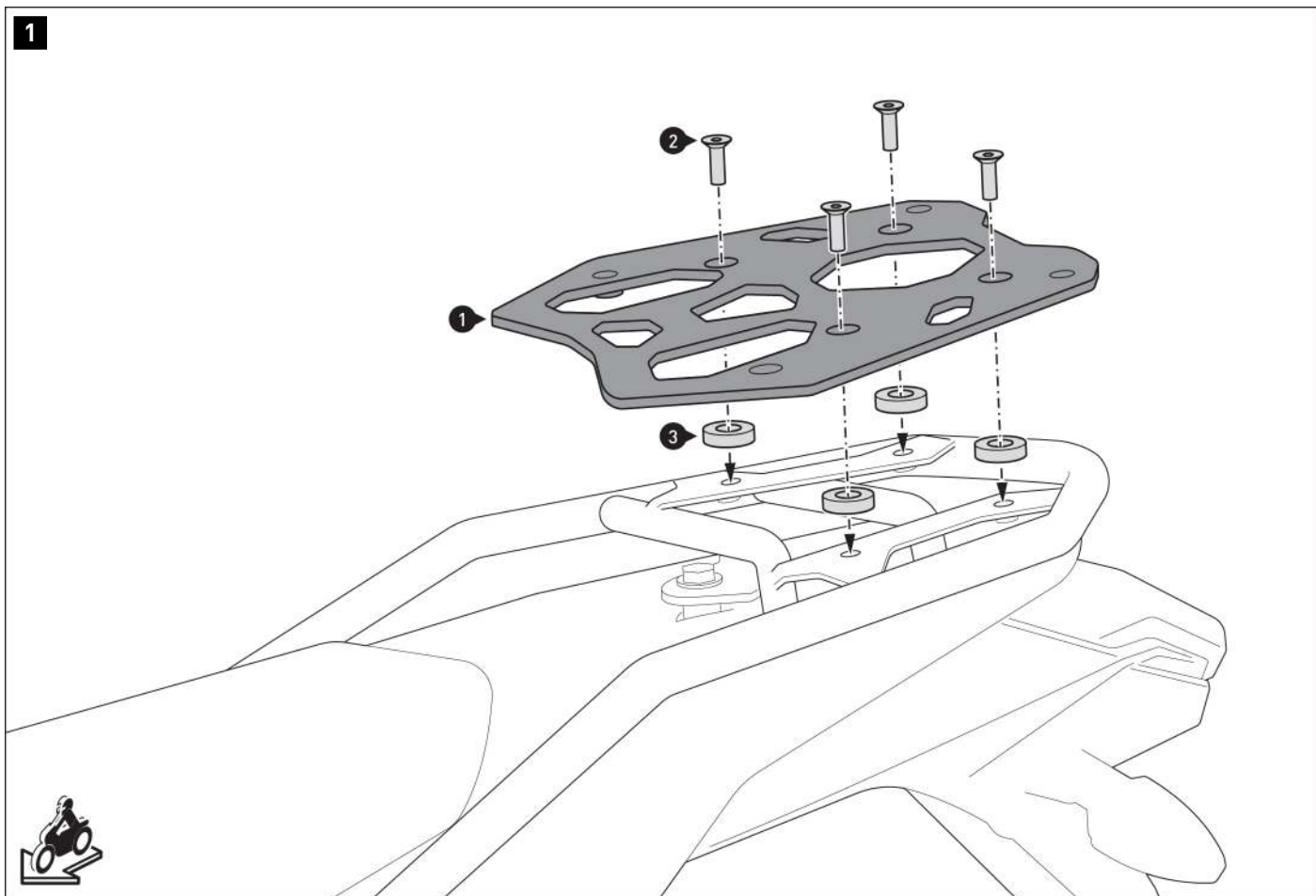

- ▲ **ATENCIÓN:** ¡Use siempre protección de ojos y manos!
- ▲ **ATENCIÓN:** ¡Utilice siempre herramientas adecuadas!

Monte la placa de fijación (1) en el portaequipaje.

- ▲ **ATENCIÓN:** ¡Utilice fijador de roscas líquido!

Apriete los tornillos tal y como se indica en las instrucciones de montaje.

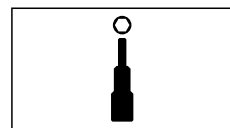
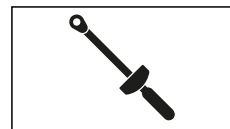
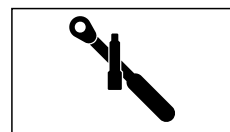
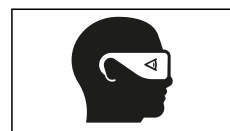

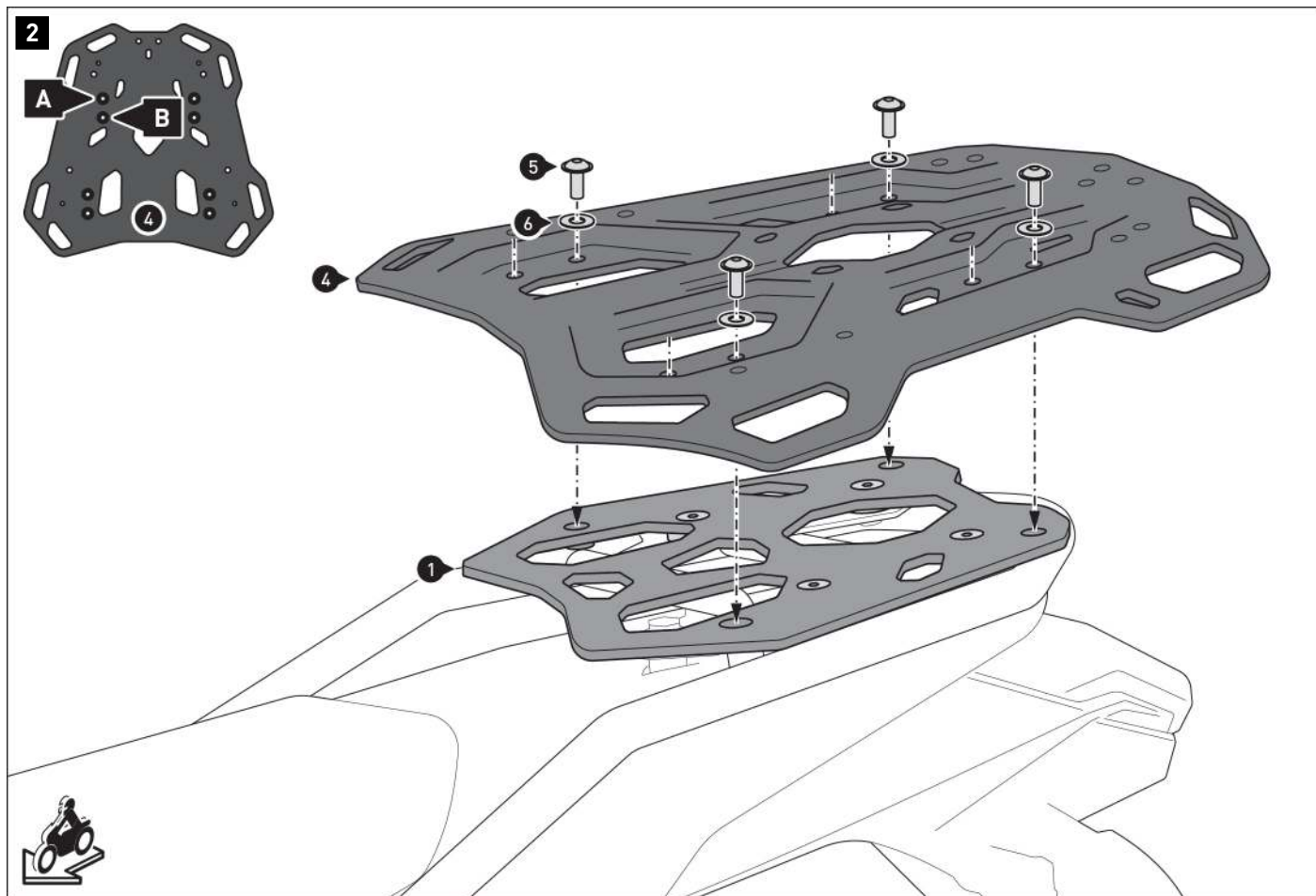

⚠ **NOTA:** Dependiendo del espacio disponible, atornille el portaequipaje en la posición de fijación marcada (A) o (B), como se muestra en el dibujo de detalle.

Monte el portaequipaje (4) en la placa de fijación (1).

⚠ **ATENCIÓN:** ¡Utilice fijador de roscas líquido!

Apriete los tornillos tal y como se indica en las instrucciones de montaje.

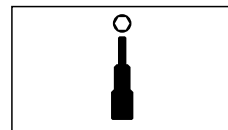
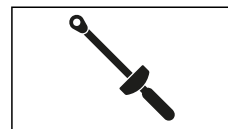

INDICACIONES ESPECÍFICAS DEL PRODUCTO

**⚠ ATENCIÓN:** ¡La carga adicional máxima indicada incluye el peso de la maleta/equipaje y la placa adaptadora/kit adaptador! ¡Se aplica la carga adicional máxima del vehículo especificada por el fabricante del mismo!



≤ 7,5 kg (≤ 16,5 libras)



≤ 130 km/h (≤ 80 mph)

**⚠ NOTA:** *Deben respetarse todas las normas nacionales para la matriculación/uso del vehículo y las normas de inspección técnica vigentes. En caso de piezas con registro obligatorio, su organismo de inspección debe registrarlas en los documentos del vehículo tras el montaje.*

Numéro d'article: GPT.02.059.19000/B

Révision: 00 · Date: 08 - 2023

## Porte-bagages ADVENTURE RACK

 ~ 0.5 h.

 FACILE      DIFFICILE

**FRANÇAIS** · Nous vous remercions d'avoir choisi ce produit haut de gamme de SW-MOTECH. Visitez notre boutique en ligne pour plus d'informations (par exemple affectation des modèles). Les documents nécessaires (par exemple ABE) y sont disponibles en téléchargement.

**Veillez lire et prendre en compte toutes les instructions, les consignes de sécurité et les avertissements contenus dans ce manuel de montage avant de monter et d'utiliser le produit afin d'éviter toute blessure ou tout dommage. Veuillez conserver la notice d'utilisation pour référence.**

**Ce produit a été développé pour des véhicules en configuration d'usine. Nous ne sommes pas en mesure d'assurer la compatibilité avec les pièces de rechange originales ou les pièces de rechange d'autres fabricants.**

**La présente notice d'installation a été élaborée conformément à nos connaissances actuelles. Il n'existe aucun droit juridique à l'exactitude des informations qu'elle contient. Sous réserve d'erreurs et de fautes. Sous réserve de modifications techniques et conceptuelles. SW-MOTECH détient les droits d'auteur.**

### SYMBOLE D'AVERTISSEMENT DE SÉCURITÉ

**⚠ Ce symbole d'avertissement est utilisé dans ces instructions de montage pour mettre en garde contre des dangers mortels, de blessures ou d'autres risques. Les mots DANGER, ATTENTION ou RECOMMANDATION sont utilisés avec ce symbole d'avertissement pour transmettre des consignes de sécurité et des informations importantes concernant le montage et l'utilisation de ce produit. Ces mots, associés au symbole d'avertissement de sécurité, signifient :**

**⚠ DANGER :** signale une situation dangereuse pouvant entraîner la mort ou des blessures graves si elle n'est pas évitée !

**⚠ ATTENTION :** signale une situation dangereuse pouvant entraîner la mort ou des blessures graves si elle n'est pas évitée !

**⚠ PRUDENCE :** Indique une situation dangereuse susceptible d'entraîner des blessures de gravité réduite ou moyenne si elle se présente !

**⚠ REMARQUE :** Informations importantes, mais qui n'entraînent pas de risque de décès ou de blessure (dommages matériels uniquement).

### REMARQUES GÉNÉRALES

**⚠ ATTENTION :** le montage et/ou l'entretien de ce produit nécessite des compétences techniques avancées, des outils appropriés et une bonne compréhension de l'utilisation des outils et des indications de réglage. Pour votre propre sécurité, SW-MOTECH recommande de confier le montage et/ou l'entretien à un atelier de réparation de deux-roues qualifié et certifié.

**⚠ ATTENTION :** si vous décidez de monter vous-même ce produit, lisez attentivement et intégralement les instructions de montage avant le montage et l'utilisation et suivez toutes les instructions afin d'éviter des blessures graves ou mortelles. Lors du montage et de l'utilisation, tenez également compte de toutes les informations pertinentes du manuel du véhicule. **SI VOUS NE COMPRENEZ PAS UNE PARTIE DE CE MANUEL D'INSTALLATION OU SI VOUS AVEZ BESOIN D'EXPLICATIONS CONCERNANT UNE INSTRUCTION, N'ESSAYEZ PAS D'INSTALLER CE PRODUIT SANS DEMANDER DE L'AIDE À SW-MOTECH !**

**PRÉPARATION :** Veuillez lire attentivement les instructions de montage et assurez-vous que tous les éléments de la liste de pièces sont présents.

**⚠ PRUDENCE :** veillez à ce que votre véhicule soit bien stable. Éteignez le moteur et retirez la clé de contact. Laissez refroidir le moteur/l'échappement si nécessaire. Débranchez la batterie lorsque vous travaillez sur le système électrique. Utilisez uniquement des outils appropriés et portez toujours des lunettes de protection et des gants pendant le montage et l'entretien. Faites-vous aider par une deuxième personne lors du montage et de l'entretien.

**MONTAGE :** Toutes les pièces et connexions retirées du véhicule doivent être réinstallées conformément aux instructions du fabricant du véhicule ou remplacées par des pièces et du matériel fournis par SW-MOTECH.

**⚠ ATTENTION** Sauf indication contraire, sécurisez tous les filetages avec du frein filet liquide de force moyenne.

**⚠ DANGER :** Les couples de serrage non définis par SW-MOTECH doivent être obtenus auprès du constructeur du véhicule ou d'un atelier de réparation de motos certifié.

**CONTRÔLE DU FONCTIONNEMENT :** Après le montage, assurez-vous qu'aucune pièce mobile n'est bloquée et que le fonctionnement du véhicule n'est pas perturbé. Les câbles et les tuyaux ne doivent pas frotter et/ou être coincés.

**⚠ ATTENTION :** Effectuez un contrôle de fonctionnement complet avant de commencer à rouler. Après les 50 premiers kilomètres, puis régulièrement, vérifiez le couple de serrage de tous les raccords et la bonne fixation du produit. Les accessoires montés peuvent modifier le comportement sur la route et la stabilité du véhicule.



SW-MOTECH GmbH & Co. KG  
Ernteweg 7-10  
35282 Rauschenberg  
Allemagne



[info@sw-motech.com](mailto:info@sw-motech.com)  
[www.sw-motech.com](http://www.sw-motech.com)



Vous trouverez les symboles et leur signification dans la section MONTAGE. Si le terme OEM apparaît dans la section MONTAGE, il faut respecter et appliquer les consignes du fabricant du véhicule.



Si vous avez des questions, notre service clientèle ainsi que nos distributeurs se tiennent à votre disposition. Vous trouverez notre numéro de téléphone ainsi que la liste de nos distributeurs sur notre boutique en ligne : [www.sw-motech.com](http://www.sw-motech.com)



**Utilisez du frein filet :** Indique qu'un filetage doit être enduit de frein filet liquide. H (HIGH) : haute résistance ; M (MEDIUM) : force moyenne ; L (LOW) : faible résistance.



**Serrer en respectant les instructions de couple de serrage :** indique le couple de serrage d'une pièce prescrit par SW-MOTECH ou par le fabricant du véhicule (OEM).

LISTE DES PIÈCES - LIRE ET CONSERVER LES INSTRUCTIONS DE MONTAGE!

1

1



GPT.02.059.001.11

 1/1

2



M6 x 20; DIN 7991  
SC.ST.06.020.48.7991.109

 4/4

3



∅ 20 / ∅ 6,4 / h 8  
DB.ST.0200.0064.0080.02

 4/4

2

4



GPT.00.152.002.11

 1/1

5



M6 x 16; ISO 7380  
SC.ST.06.016.02.7380.109

 4/4

6



∅ 6,4; DIN 9021  
US.ST.064.02.9021

 4/4

1

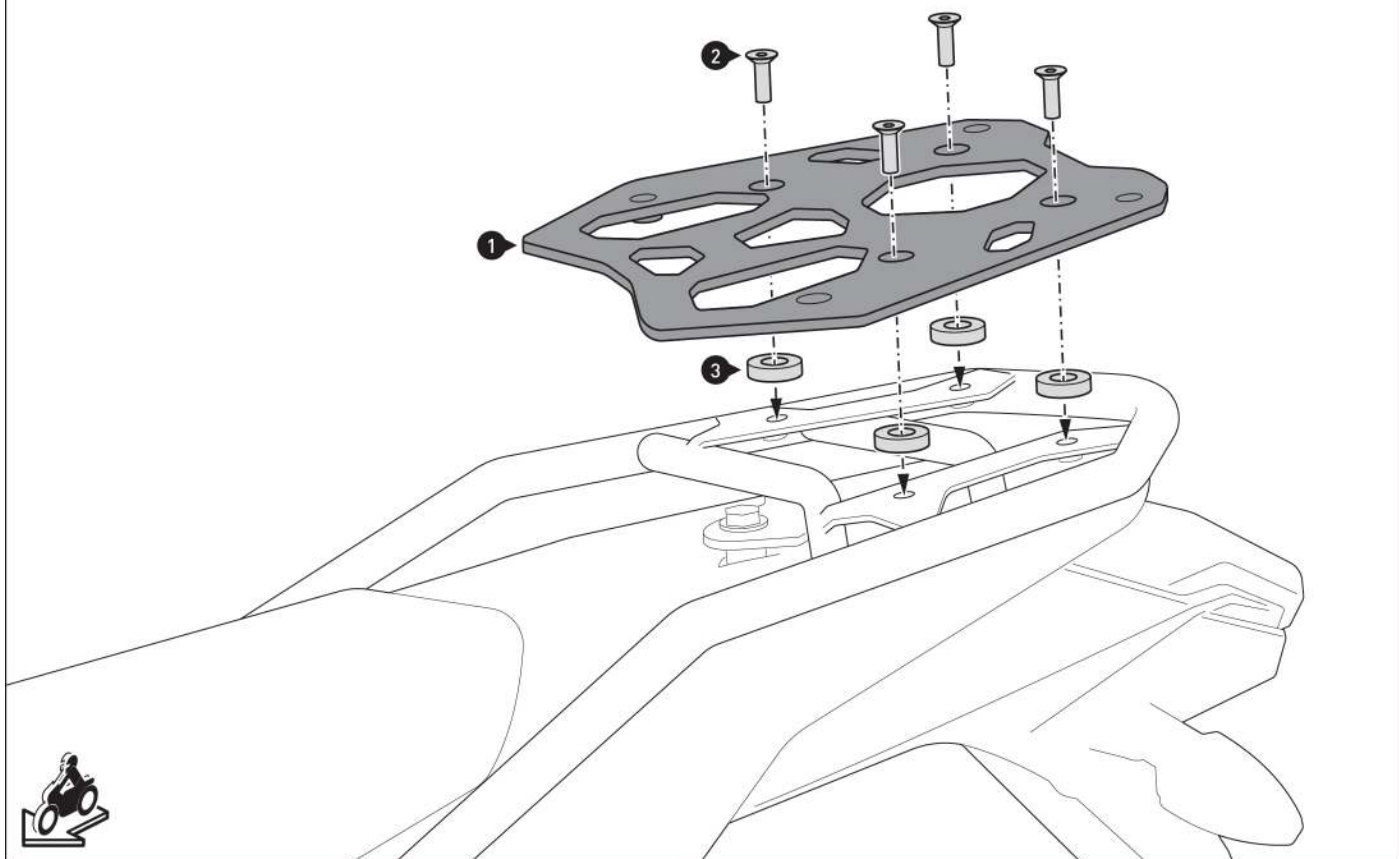

- ▲ ATTENTION : portez toujours des lunettes et des gants de protection !
- ▲ ATTENTION : Utilisez toujours des outils appropriés !

Fixez le support de fixation (1) sur le porte-bagages.

- ▲ ATTENTION : utilisez du frein filet liquide !

Serrez les vis comme indiqué dans les instructions de montage.

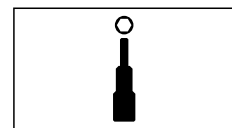
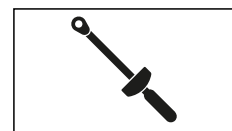
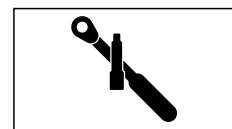
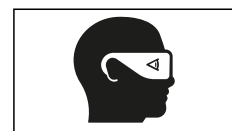

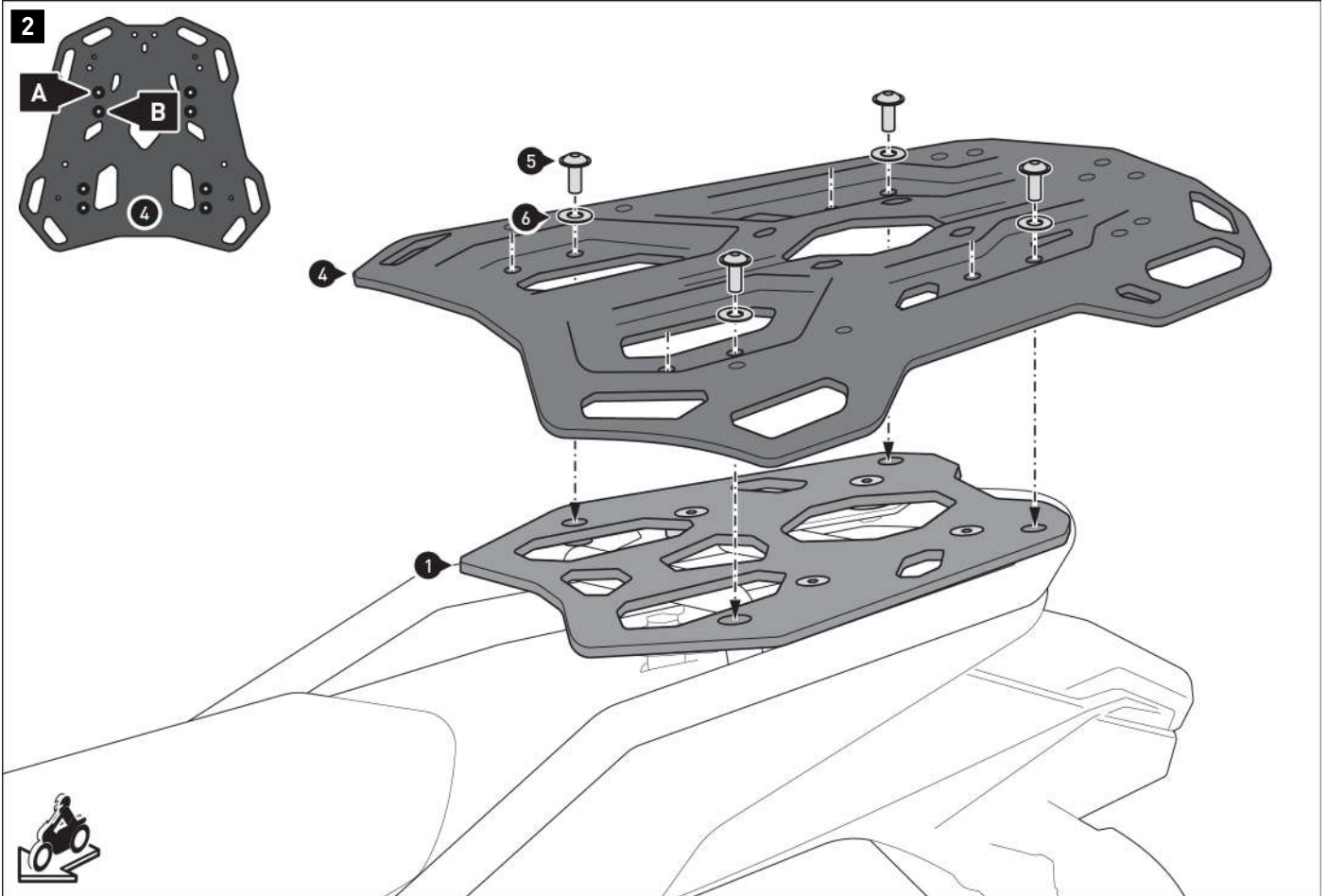

**⚠ REMARQUE :** En fonction de la place disponible, vissez le porte-bagages aux positions de fixation marquées (A) ou (B), comme indiqué sur le dessin détaillé.

Montez le porte-bagages (4) sur la plaque de montage (1).

**⚠ ATTENTION :** utilisez du frein filet liquide !

Serrez les vis comme indiqué dans les instructions de montage.

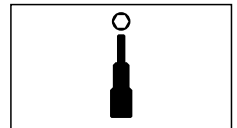
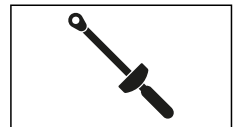



REMARQUES SPÉCIFIQUES AU PRODUIT

**⚠ ATTENTION** : la charge maximale indiquée comprend le poids de la valise/du bagage et de la platine d'adaptation/du kit d'adaptation ! La charge maximale indiquée par le constructeur du véhicule s'applique !



≤ 7,5 KG (≤ 16,5 lbs)



≤ 130 km/h (≤ 80mph)

**⚠ REMARQUE** : respectez toutes les réglementations spécifiques à chaque pays pour l'immatriculation et l'utilisation de votre véhicule ainsi que les réglementations TÜV applicables. Après le montage, faites ajouter les pièces soumises à enregistrement dans les documents du véhicule par votre centre de contrôle.

Numero di articolo: GPT.02.059.19000/B

Revisione: 00 · Data: 08 - 2023

## Portabagagli ADVENTURE RACK

 ~ 0.5 h.

 FACILE      DIFFICILE

**ITALIANO** -Grazie per aver scelto questo prodotto premium di SW-MOTECH. Visita il nostro negozio online per ulteriori informazioni (ad es. per la compatibilità con i vari modelli). I documenti richiesti (ad es. certificato di omologazione nazionale) possono essere scaricati qui.

**Si prega di leggere attentamente le avvertenze di sicurezza e le istruzioni per il montaggio prima di montare e utilizzare il prodotto, al fine di evitare eventuali lesioni e danni. Conserva queste istruzioni per il montaggio come riferimento futuro.**

Questo prodotto è stato sviluppato per veicoli in condizioni di fabbrica. La compatibilità con gli accessori originali o di altri produttori non può essere garantita.

Queste istruzioni per il montaggio sono state redatte in base alle nostre conoscenze attuali. Non sussistono pretese di correttezza giuridiche. Salvo errori ed omissioni. Ci riserviamo il diritto di apportare modifiche tecniche e di design. Copyright SW-MOTECH.

### SIMBOLO DI SICUREZZA

 Questo simbolo di avvertenza è usato nelle presenti istruzioni di montaggio per segnalare pericoli mortali, rischio di lesioni o altri pericoli. Le parole "PERICOLO", "AVVERTENZA" O "ATTENZIONE" sono utilizzate con questo simbolo di avvertenza per trasmettere importanti istruzioni di sicurezza e informazioni relative al montaggio e all'uso di questo prodotto. Queste parole, utilizzate insieme al simbolo di avvertenza, significano:

**▲ PERICOLO:** indica una situazione di pericolo che, se non evitata, può causare morte o lesioni gravi!

**▲ AVVERTENZA:** indica una situazione di pericolo che, se non evitata, può causare morte o lesioni gravi!

**▲ ATTENZIONE:** indica una situazione di pericolo che, se non evitata, può provocare lesioni lievi o di entità moderata!

**▲ AVVISO:** indica informazioni importanti che non riguardano il rischio di morte o di lesioni (riguardano unicamente il rischio di danni materiali)!

### INFORMAZIONI GENERALI

**▲ AVVERTENZA:** il montaggio e/o la manutenzione di questo prodotto richiedono competenze tecniche avanzate, strumenti adeguati e una buona conoscenza dell'uso della strumentazione e delle indicazioni relative alle coppie di serraggio. Per ragioni di sicurezza, SW-MOTECH raccomanda di far eseguire il montaggio e/o la manutenzione presso un'officina per motociclette qualificata e certificata.

**▲ AVVERTENZA:** se si decide di installare questo prodotto in autonomia, leggere attentamente le istruzioni per il montaggio prima del montaggio e dell'uso e seguire tutte le avvertenze per evitare lesioni gravi o mortali. Durante il montaggio e l'uso, seguire anche tutte le istruzioni pertinenti contenute nel manuale del veicolo. **SE NON SI COMPRENDONO TALI ISTRUZIONI, ANCHE SOLO IN PARTE, O SE SONO NECESSARI CHIARIMENTI, NON CERCARE DI MONTARE IL PRODOTTO IN AUTONOMIA SENZA CHIEDERE IL SUPPORTO DI SW-MOTECH!**

**PREPARAZIONE:** leggere attentamente le istruzioni per il montaggio e assicurarsi che siano disponibili tutti i componenti contenuti nella lista.

**▲ ATTENZIONE:** assicurarsi che il veicolo sia perfettamente fermo. Spegner il motore e togliere la chiave. Se necessario, lasciar raffreddare il motore/lo scarico. Scollegare la batteria quando si interviene sull'impianto elettrico. Usare esclusivamente strumenti idonei e indossare sempre occhiali e guanti protettivi durante le operazioni di montaggio e manutenzione. Chiedere aiuto a una seconda persona durante le fasi di montaggio e manutenzione.

**MONTAGGIO:** tutti i componenti e i collegamenti rimossi dal veicolo devono essere reinstallati secondo le specifiche del produttore del veicolo o sostituiti con componenti e attrezzatura forniti da SW-MOTECH.

**▲ AVVERTENZA:** fissare tutte le filettature con frenafili liquido a media resistenza, se non diversamente specificato.

**▲ PERICOLO:** le coppie di serraggio non definite da SW-MOTECH devono essere richieste al costruttore del veicolo o a un'officina certificata.

**CONTROLLO DI FUNZIONALITÀ:** dopo il montaggio accertarsi che non vi siano parti mobili bloccate e che il funzionamento del veicolo non sia compromesso. I cavi e i tubi flessibili non devono sfregare e/o essere schiacciati.

**▲ AVVERTENZA:** eseguire un controllo completo delle funzioni prima di mettersi alla guida. Controllare la coppia di serraggio di tutti i collegamenti e la tenuta del prodotto dopo i primi 50 km e in seguito regolarmente. Gli accessori montati possono modificare la maneggevolezza e la stabilità del veicolo.



SW-MOTECH GmbH & Co. KG  
Ernteweg 7-10  
35282 Rauschenberg  
Germania



info@sw-motech.com  
www.sw-motech.com



Consultare i simboli e il loro significato nella sezione MONTAGGIO. Se nella sezione montaggio compare la sigla OEM, è necessario rispettare e applicare le specifiche del produttore del veicolo.



Per qualsiasi domanda, non esitare a contattare il nostro servizio clienti o i nostri distributori. Il nostro numero di telefono e l'elenco dei nostri distributori sono disponibili nel nostro negozio online:

**[www.sw-motech.com](http://www.sw-motech.com)**



**Usare un frenafiletto:** indica che la filettatura deve essere rivestita con un frenafiletto liquido. H (ALTA): alta resistenza; M (MEDIA): media resistenza; L (BASSO): bassa resistenza.



**Serraggio / rispetto delle specifiche sulla coppia di serraggio:** indica la coppia di serraggio di un componente specificata da SW-MOTECH o dal produttore del veicolo (OEM).

ELENCO DELLE PARTI - LEGGI E CONSERVA LE ISTRUZIONI DI MONTAGGIO!

1

1



GPT.02.059.001.11

 1/1

2



M6 x 20; DIN 7991  
SC.ST.06.020.48.7991.109

 4/4

3



∅ 20 / ∅ 6,4 / h 8  
DB.ST.0200.0064.0080.02

 4/4

2

4



GPT.00.152.002.11

 1/1

5



M6 x 16; ISO 7380  
SC.ST.06.016.02.7380.109

 4/4

6



∅ 6,4; DIN 9021  
US.ST.064.02.9021

 4/4

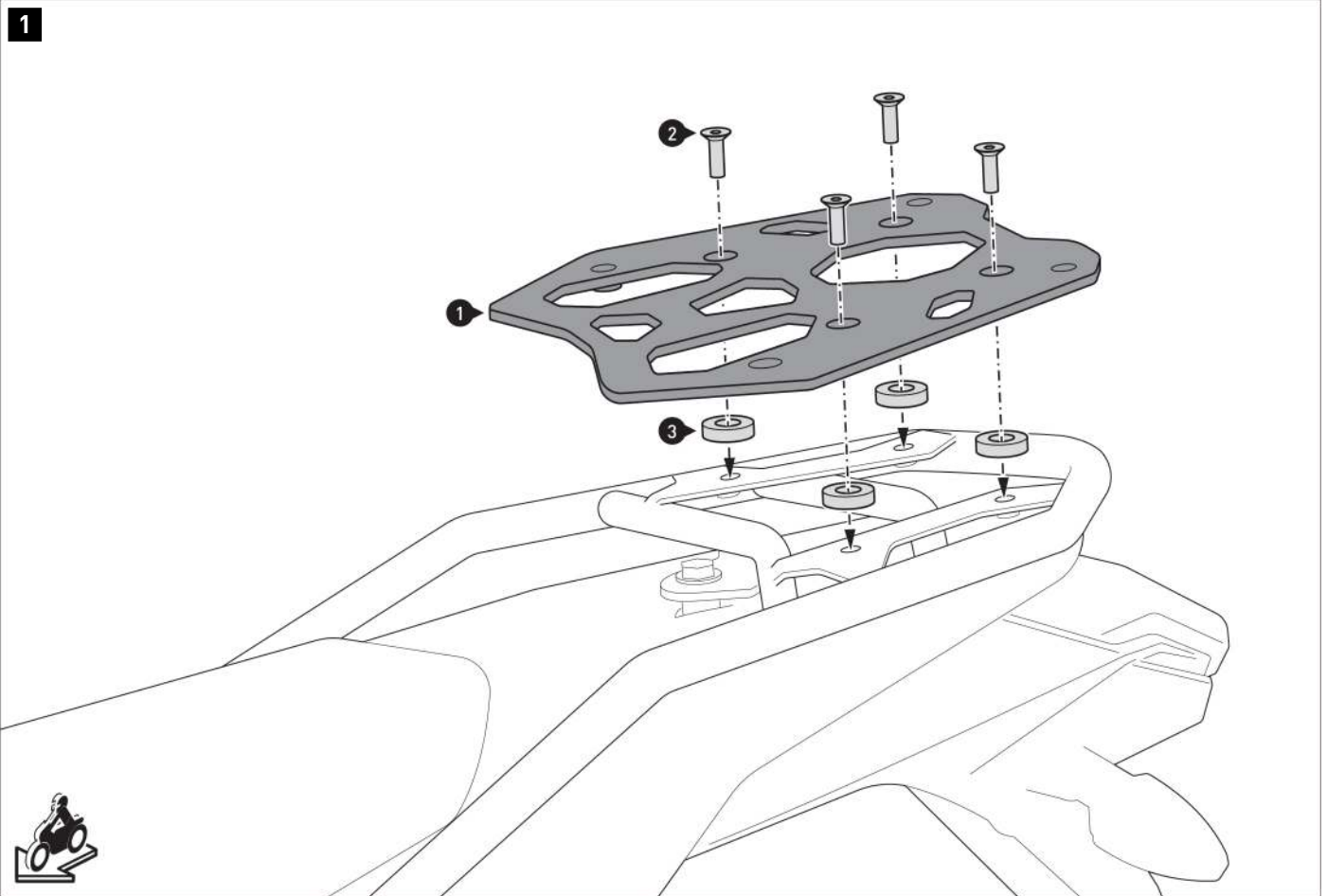

- ▲ AVVERTENZA: indossare sempre le protezioni per gli occhi e per le mani!
- ▲ AVVERTENZA: Utilizzare sempre strumenti adeguati!

Montare la staffa di montaggio (1) sul portabagagli.

- ▲ AVVERTENZA: Usare un frenafiletto liquido!
- Serrare le viti come indicato nelle istruzioni per il montaggio.

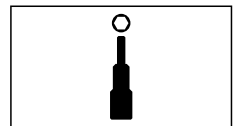
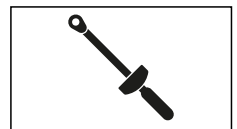
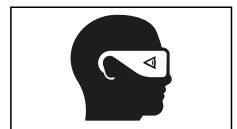

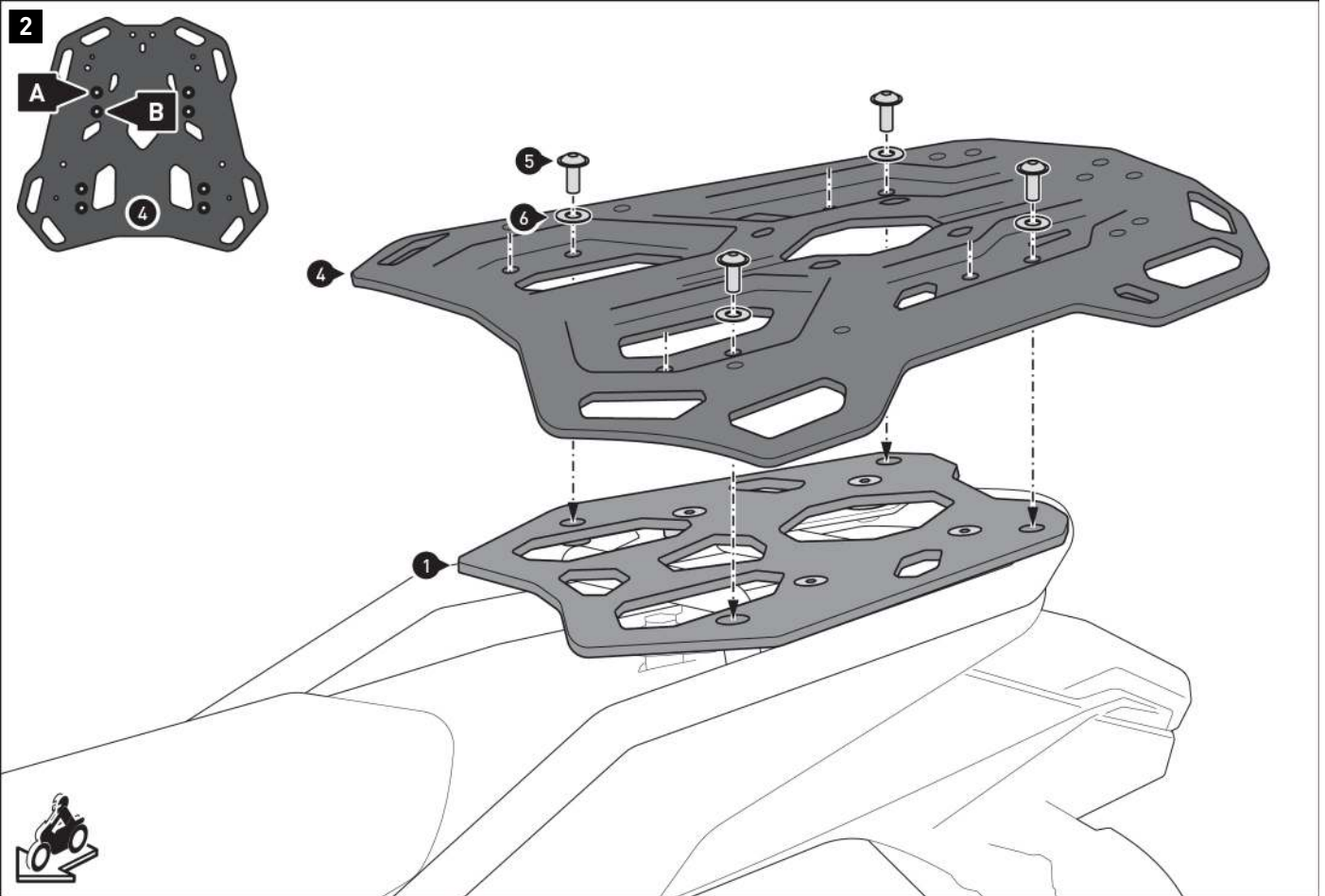

**⚠ AVVISO:** a seconda dello spazio disponibile, avvitare il portabagagli in corrispondenza della posizione di montaggio contrassegnata (A) o (B), come mostrato in dettaglio nell'illustrazione.

Montare il portabagagli (4) sulla staffa di montaggio (1).

**⚠ AVVERTENZA:** Usare un frenafretilletti liquido!

Serrare le viti come indicato nelle istruzioni per il montaggio.

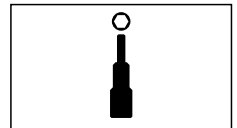
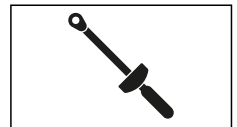

**AVVERTENZE SPECIFICHE DEL PRODOTTO**

**⚠ AVVERTENZA:** il carico massimo specificato comprende il peso della valigia/bagaglio e della piastra di adattamento/kit adattatore! Si applica il carico massimo del veicolo specificato dal costruttore del veicolo!

 ≤ 7,5 KG (≤ 16,5 libbre) |  ≤ 130 km/h (≤ 80 mph)

**⚠ AVVISO:** rispettare le normative specifiche del paese per l'immatricolazione/l'uso del veicolo, come le normative TÜV applicabili. Dopo il montaggio, far inserire le parti soggette a omologazione nei documenti del veicolo dal proprio centro di test.

Art.-Nr.: GPT.00.152.36200/B

Revision: 00 · Datum: 08 - 2023

## Adapterkit für ADVENTURE-RACK Gepäckträger

 ~ 0.25 h.LEICHT     SCHWER

**DEUTSCH** - Vielen Dank, dass Sie sich für dieses Premium-Produkt von SW-MOTECH entschieden haben. Besuchen Sie unseren Webshop für weitere Informationen (z. B. Modellzuweisungen). Erforderliche Dokumente (z. B. ABE) stehen Ihnen dort als Download zur Verfügung.

Bitte lesen und verstehen Sie alle Anweisungen, Sicherheitshinweise und Warnungen in dieser Anbauanleitung vor Montage und Nutzung des Produkts, um Verletzungen und Schäden zu vermeiden. Bewahren Sie diese Anbauanleitung als Referenz auf.

Dieses Produkt wurde für Fahrzeuge im Werkzustand entwickelt. Die Kompatibilität mit Original-Zubehörteilen bzw. den Zubehörteilen anderer Hersteller kann nicht gewährleistet werden.

Diese Anbauanleitung ist nach unserem derzeitigen Kenntnisstand verfasst worden. Rechtliche Ansprüche auf Richtigkeit bestehen nicht. Fehler und Irrtümer vorbehalten. Technische und gestalterische Änderungen sind vorbehalten. Das Urheberrecht liegt bei SW-MOTECH.

## SICHERHEITSWARNUNGSSYMBOL

 Dieses Warnsymbol wird in dieser Anbauanleitung verwendet, um vor tödlichen Gefahren, Verletzungen oder anderen Gefahren zu warnen. Die Wörter **GEFAHR**, **WARNUNG** oder **VORSICHT** werden mit diesem Warnsymbol verwendet, um wichtige Sicherheitshinweise und Informationen in Bezug auf die Montage und Nutzung dieses Produkts zu übermitteln. Diese Wörter zusammen mit dem Sicherheitswarnsymbol bedeuten:

**GEFAHR:** Weist auf eine gefährliche Situation hin, die zum Tod oder zu schweren Verletzungen führt, wenn sie nicht vermieden wird!

**WARNUNG:** Weist auf eine gefährliche Situation hin, die zum Tod oder zu schweren Verletzungen führen kann, wenn sie nicht vermieden wird!

**VORSICHT:** Weist auf eine gefährliche Situation hin, die zu leichten oder mittelschweren Verletzungen führen kann, wenn sie nicht vermieden wird!

**HINWEIS:** Wichtige Informationen, jedoch nicht in Bezug auf Todes- oder Verletzungsgefahr (nur Sachschäden)!

## ALLGEMEINE HINWEISE

**WARNUNG:** Die Montage und/oder Wartung dieses Produkts erfordert fortgeschrittene technische Fähigkeiten, geeignetes Werkzeug und ein gutes Verständnis der Werkzeugnutzung und Drehmomentangaben. Zu Ihrer eigenen Sicherheit empfiehlt SW-MOTECH, die Montage und/oder Wartung von einer qualifizierten und zertifizierten Zweiradwerkstatt durchführen zu lassen.

**WARNUNG:** Wenn Sie sich für die Eigenmontage dieses Produkts entscheiden, lesen Sie vor Montage und Nutzung die Anbauanleitung sorgfältig und vollständig durch und befolgen Sie alle Anweisungen, um schwere oder tödliche Verletzungen zu vermeiden. Beachten Sie bei der Montage und Verwendung auch alle relevanten Informationen im Fahrzeughandbuch. **WENN SIE EINEN TEIL DIESER ANBAUANLEITUNG NICHT VERSTEHEN ODER EINE ERKLÄRUNG EINER ANWEISUNG BENÖTIGEN, VERSUCHEN SIE NICHT DIESES PRODUKT ZU MONTIEREN, OHNE SW-MOTECH UM HILFE ZU FRAGEN!**

**VORBEREITUNG:** Lesen Sie die Anbauanleitung aufmerksam und stellen Sie sicher, dass alle Teile der Stückliste vorhanden sind.

**VORSICHT:** Achten Sie auf den sicheren Stand Ihres Fahrzeugs. Schalten Sie den Motor ab und ziehen Sie den Zündschlüssel. Lassen Sie den Motor/Auspuff bei Bedarf abkühlen. Klemmen Sie die Batterie bei Arbeiten an der Elektrik ab. Verwenden Sie nur geeignetes Werkzeug und tragen Sie während der Montage und Wartung immer eine Schutzbrille und Handschuhe. Lassen Sie sich bei der Montage und Wartung von einer zweiten Person helfen.

**MONTAGE:** Alle vom Fahrzeug entfernten Teile und Verbindungen müssen gemäß den Angaben des Fahrzeugherstellers wieder eingebaut oder durch von SW-MOTECH gelieferte Teile und Hardware ersetzt werden.

**WARNUNG:** Sichern Sie alle Gewinde, sofern nicht anders angegeben, mit mittelstarker, flüssiger Schraubensicherung.

**GEFAHR:** Von SW-MOTECH nicht definierte Anzugsdrehmomente müssen Sie vom Fahrzeughersteller oder von einer zertifizierten Motorradwerkstatt beziehen.

**FUNKTIONSKONTROLLE:** Stellen Sie nach der Montage sicher, dass keine beweglichen Teile blockiert sind und die Funktion des Fahrzeugs nicht gestört wird. Kabel und Schläuche dürfen nicht scheuern und/oder geklemmt werden.

**WARNUNG:** Führen Sie vor Fahrtbeginn eine umfassende Funktionskontrolle durch. Prüfen Sie nach den ersten 50 km und dann regelmäßig das Anzugsmoment aller Verbindungen und den festen Sitz des Produkts. Montiertes Zubehör kann das Fahrverhalten und die Stabilität des Fahrzeugs verändern.



SW-MOTECH GmbH & Co. KG  
Ernteweg 7-10  
35282 Rauschenberg  
Deutschland



[info@sw-motech.com](mailto:info@sw-motech.com)  
[www.sw-motech.com](http://www.sw-motech.com)





Beachten Sie in dem Abschnitt MONTAGE vorkommenden Symbole und deren Bedeutung. Wenn im Abschnitt MONTAGE die Bezeichnung OEM vorkommt, müssten die Vorgaben des Fahrzeugherstellers beachtet und angewandt werden.



Bei Fragen steht Ihnen unser Kundendienst sowie unsere Distributoren gerne zur Verfügung. Unsere Telefonnummer sowie eine Liste unserer Distributoren finden Sie in unserem Webshop: [www.sw-motech.com](http://www.sw-motech.com)



**Schraubensicherung verwenden:** Weist darauf hin, dass ein Gewinde mit flüssiger Schraubensicherung bestrichen werden muss. H (HIGH): hohe Festigkeit; M (MEDIUM): mittlere Festigkeit; L (LOW): niedrige Festigkeit.



**Anziehen / Anzugsmomentangabe beachten:** Weist auf das von SW-MOTECH bzw. vom Fahrzeughersteller (OEM) vorgegebene Anzugsmoment eines Teils hin.

STÜCKLISTE - ANBAUANLEITUNG LESEN UND AUFBEWAHREN!

1

1



HSK.00.745.025.35GR

 1/1

2



M6 x 14; ISO 7380  
SC.ST.06.014.02.7380.109

 2/2

3



GPT.00.152.035.02

 4/4

4



GPT.00.152.010.35

 2/2

5



M6 x 25; DIN 7991  
SC.ST.06.025.02.7991.088

 2/2

1

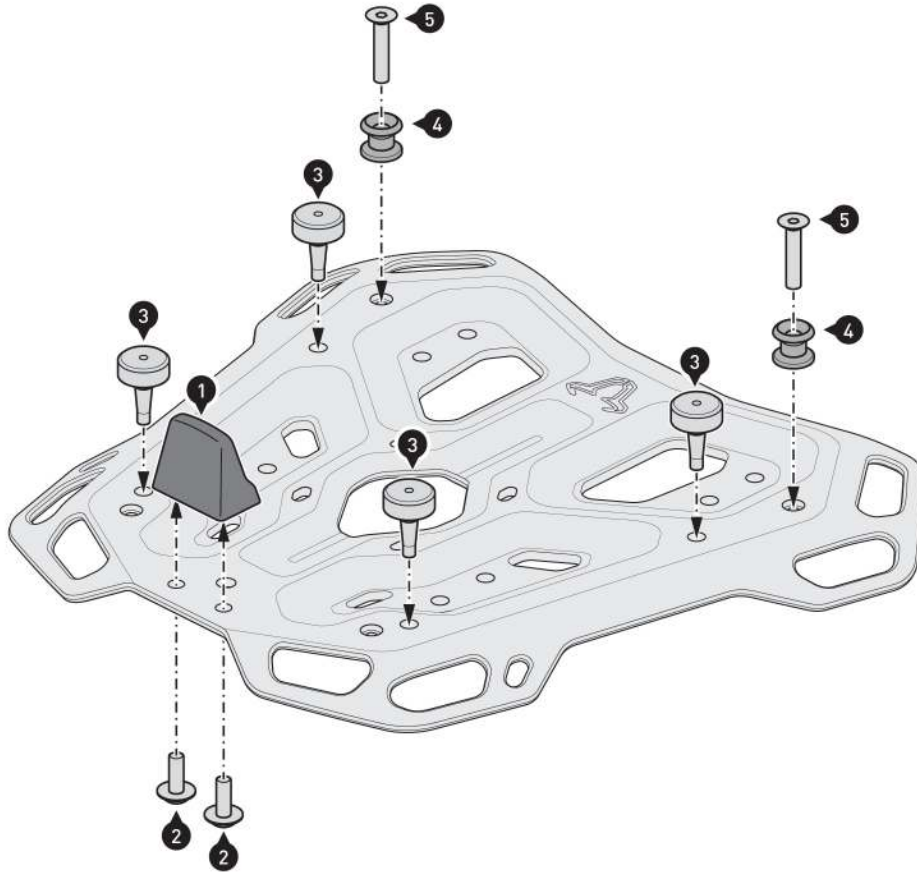

**▲ WARNUNG: Tragen Sie immer Augen- und Handschutz!**  
**▲ WARNUNG: Verwenden Sie immer geeignetes Werkzeug!**

Montieren Sie die gezeigten Teile an Ihrem Gepäckträger.  
**▲ WARNUNG: Verwenden Sie flüssige Schraubensicherung!**  
 Ziehen Sie die Schrauben wie in der Anbauanleitung vorgegeben an.

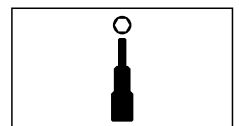
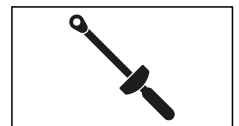
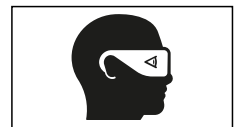

**PRODUKTSPEZIFISCHE HINWEISE**

**⚠ HINWEIS:** Beachten Sie die landesspezifischen Vorschriften für Zulassung/Betrieb Ihres Fahrzeugs bzw. anwendbare TÜV-Vorschriften. Lassen Sie eintragungspflichtige Teile nach Montage durch Ihre Prüfstelle in die Fahrzeugpapiere eintragen.

Item number: GPT.00.152.36200/B

Revision: 00 · Date: 08 - 2023

## Adapter kit for ADVENTURE-RACK

 ~ 0.25 h.

 EASY      DIFFICULT

**ENGLISH** Thank you for choosing this premium product from SW-MOTECH. Visit our online shop for more information (e.g. model assignments). Required documents (e.g. national type approval) are available there for you to download.

Please read and understand all the instructions, safety information and warnings in these mounting instructions before mounting and using the product in order to avoid injury and damage. Keep these mounting instructions for reference.

This product was developed for vehicles in factory condition. Compatibility with original accessories or accessories from other manufacturers cannot be guaranteed.

These mounting instructions have been prepared to the best of our current knowledge. No legal claims relating to accuracy can be made. Errors and omissions excepted. We reserve the right to make technical and design changes. The copyright is held by SW-MOTECH.

### SAFETY WARNING SYMBOL

 This warning symbol is used in these mounting instructions to warn of deadly dangers, injuries or other hazards. The words **DANGER**, **WARNING** or **CAUTION** are used as part of this warning symbol to convey important safety messages and information relating to the installation and use of this product. These words, together with the safety warning symbol, mean:

 **DANGER:** Indicates a hazardous situation which, if not avoided, will result in death or serious injury!

 **WARNING:** Indicates a hazardous situation which, if not avoided, may result in death or serious injury!

 **CAUTION:** Indicates a hazardous situation which, if not avoided, may result in minor or moderate injury!

 **NOTE:** Important information, but not relating to a risk of death or injury (property damage only)!

### GENERAL INFORMATION

 **WARNING:** Assembly and/or maintenance of this product requires advanced technical skill, appropriate tools, and a good understanding of tool usage and torque specifications. For your own safety, SW-MOTECH recommends having the assembly and/or maintenance carried out by a qualified and certified motorcycle workshop.

 **WARNING:** If you do choose to assemble this product yourself, carefully and fully read the mounting instructions before assembly and use, and follow all instructions to avoid serious injury or death. Also observe all relevant information in the vehicle manual when mounting or using the product. IF YOU DO NOT UNDERSTAND ANY PART OF THESE MOUNTING INSTRUCTIONS OR NEED AN EXPLANATION AS TO A SPECIFIC INSTRUCTION, DO NOT ATTEMPT TO INSTALL THIS PRODUCT WITHOUT CONSULTING SW-MOTECH FOR ASSISTANCE!

**PREPARATION:** Read the mounting instructions carefully and make sure that all parts on the parts list are available.

 **CAUTION:** Ensure that your vehicle is standing securely. Switch off the engine and remove the ignition key. Allow the engine/exhaust to cool down if necessary. Disconnect the battery when working on the electrical system. Only use proper tools and always wear safety goggles and gloves during assembly and maintenance. Have a second person help you with assembly and maintenance.

**ASSEMBLY:** All parts and connections removed from the vehicle must be reinstalled according to the vehicle manufacturer's specifications or replaced with parts and hardware supplied by SW-MOTECH.

 **WARNING:** Secure all threads with a medium-strength liquid threadlocker, unless otherwise specified.

 **DANGER:** Tightening torques not defined by SW-MOTECH must be obtained from the vehicle manufacturer or a certified motorbike workshop.

**FUNCTIONAL CHECK:** After mounting the product, ensure that no moving parts are obstructed and that the function of the vehicle is not impeded. Cables and hoses must not rub against each other and/or be hindered in any way.

 **WARNING:** Carry out a comprehensive functionality check before you start to drive. Check the tightening torque of all connections and the tight fit of the product after the first 50 km and then at regular intervals. Mounted accessories can change the handling and stability of the vehicle.



SW-MOTECH GmbH & Co. KG  
Ernteweg 7-10  
35282 Rauschenberg  
Germany



 [info@sw-motech.com](mailto:info@sw-motech.com)  
 [www.sw-motech.com](http://www.sw-motech.com)



Take note of the symbols and what they mean in the ASSEMBLY section. If the term OEM appears in the ASSEMBLY section, the vehicle manufacturer's specifications must be observed and applied.



If you have any questions, please don't hesitate to contact our Customer Service team or our distributors. You can find our telephone number and a list of our distributors in our online shop:

**[www.sw-motech.com](http://www.sw-motech.com)**



**Use thread locker:** Indicates that a thread must be coated with liquid thread locker. H (HIGH): high strength; M (MEDIUM): medium strength; L (LOW): low strength.



**Tighten/note the tightening torque information:**

Indicates the tightening torque of a part specified by SW-MOTECH or the vehicle manufacturer (OEM).

**PARTS LIST - READ AND KEEP MOUNTING INSTRUCTIONS!**

**1**

**1**



HSK.00.745.025.35GR

 **1/1**

**2**



M6 x 14; ISO 7380  
SC.ST.06.014.02.7380.109

 **2/2**

**3**



GPT.00.152.035.02

 **4/4**

**4**



GPT.00.152.010.35

 **2/2**

**5**



M6 x 25; DIN 7991  
SC.ST.06.025.02.7991.088

 **2/2**

1



**▲ WARNING: Always wear eye and hand protection!**  
**▲ WARNING: Always use the proper tools!**

Mount the parts shown to your rack.

**▲ WARNING: Use a liquid threadlocker!**

Tighten the screws as specified in the mounting instructions.

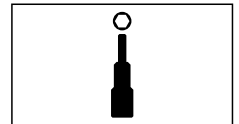



**PRODUCT-SPECIFIC NOTES**

**⚠ NOTE:** *Observe the country-specific regulations for the registration/operation of your vehicle or applicable TÜV regulations. After assembly, have parts that are subject to registration entered in the vehicle documents by your test centre.*

Número de artículo: GPT.00.152.36200/B

Revisión: 00 · Fecha: 08 - 2023

## Kit de adaptadores para ADVENTURE-RACK

 ~ 0.25 h.

 FÁCIL     COMPLICADO

**ESPAÑOL** · Gracias por elegir este producto de primera calidad de SW-MOTECH. Visite nuestra tienda online para obtener más información (p. ej., sobre el uso de los modelos). Desde esa página podrá descargar los documentos que necesite (por ejemplo, la homologación nacional de tipo).

Para evitar lesiones y daños, asegúrese de leer y comprender todas las instrucciones, advertencias de seguridad y precauciones de este manual antes de montar y utilizar el producto. Guarde estas instrucciones de montaje como referencia.

Este producto ha sido desarrollado para vehículos en condiciones de fábrica. No se garantiza la compatibilidad con los accesorios originales o de otros fabricantes.

Estas instrucciones de montaje se han redactado de acuerdo con nuestros conocimientos actuales. No hay reclamaciones legales de corrección. Salvo errores y omisiones. Nos reservamos el derecho a realizar cambios técnicos y de diseño. Los derechos de autor pertenecen a SW-MOTECH.

### SÍMBOLO DE ADVERTENCIA DE SEGURIDAD

 Este símbolo de advertencia se utiliza en estas instrucciones de montaje para advertir de peligros mortales, lesiones u otros riesgos. Las palabras PELIGRO, ATENCIÓN o PRECAUCIÓN se utilizan con este símbolo de advertencia para transmitir importantes avisos de seguridad e información relacionada con el montaje y uso de este producto. Estas palabras, junto con el símbolo de advertencia de seguridad, significan:

 **PELIGRO:** Indica una situación de peligro que, si no se evita, provoca lesiones graves o incluso la muerte.

 **ATENCIÓN:** Indica una situación de peligro que, si no se evita, puede provocar lesiones graves o incluso la muerte.

 **PRECAUCIÓN:** Indica una situación de peligro que, si no se evita, puede provocar lesiones leves o de gravedad media.

 **NOTA:** Información importante, pero que no está relacionada con un riesgo de lesiones o muerte (solo daños materiales).

### INDICACIONES GENERALES

 **ATENCIÓN:** El montaje y/o mantenimiento de este producto requiere conocimientos técnicos avanzados, las herramientas apropiadas, un buen manejo de dichas herramientas y conocer las especificaciones de los pares de apriete. Por su propia seguridad, SW-MOTECH recomienda que el montaje y/o el mantenimiento los realice un taller de motocicletas cualificado y certificado.

 **ATENCIÓN:** Si elige ensamblar este producto usted mismo, antes de montarlo y usarlo, lea las instrucciones de montaje detenidamente y en su totalidad, y siga todas las indicaciones para evitar lesiones graves o mortales. Cuando monte y utilice el producto, tenga también en cuenta toda la información relevante que figure en el manual del vehículo. SI NO ENTIENDE ALGUNA PARTE DE ESTAS INSTRUCCIONES DE MONTAJE O NECESITA ALGUNA ACLARACIÓN, NO INTENTE INSTALAR ESTE PRODUCTO SIN CONSULTAR A SW-MOTECH PARA OBTENER AYUDA.

**PREPARACIÓN:** Lea atentamente las instrucciones de montaje y asegúrese de que todas las piezas de la lista de piezas están presentes.

 **PRECAUCIÓN:** Asegúrese de que su vehículo esté estacionado de manera segura. Apague el motor y retire la llave de encendido. Deje que el motor o el escape se enfrien si es necesario. Desconecte la batería cuando trabaje en el sistema eléctrico. Utilice únicamente las herramientas adecuadas y use siempre gafas de seguridad y guantes al realizar el montaje y las tareas de mantenimiento. Pida a otra persona que le ayude con el montaje y el mantenimiento.

**MONTAJE:** Todas las piezas y conexiones retiradas del vehículo deben ser reinstaladas de acuerdo con las especificaciones del fabricante del vehículo o sustituidas por piezas y herrajes suministrados por SW-MOTECH.

 **ATENCIÓN:** Asegure todas las roscas con fijador de roscas líquido de resistencia media, a menos que se especifique lo contrario.

 **PELIGRO:** Los pares de apriete no definidos por SW-MOTECH deben obtenerse del fabricante del vehículo o de un taller de motocicletas certificado.

**COMPROBACIÓN FUNCIONAL:** Después del montaje, asegúrese de que no haya piezas móviles bloqueadas y de que no se altere el funcionamiento del vehículo. Los cables y tubos no deben rozarse ni quedar pinzados.

 **ATENCIÓN:** Realice una comprobación exhaustiva del funcionamiento antes de iniciar la marcha. Tras los primeros 50 km y, después, con regularidad, compruebe el par de apriete de todas las conexiones y que el producto está firmemente sujeto. Los accesorios instalados pueden cambiar el comportamiento de conducción y la estabilidad del vehículo.



SW-MOTECH GmbH & Co. KG  
Ernteweg 7-10  
35282 Rauschenberg  
Alemania



✉ info@sw-motech.com  
🌐 www.sw-motech.com



Preste atención a los símbolos que figuran en la sección de MONTAJE y su significado. Cuando, en la sección de MONTAJE, aparecen las siglas OEM, se deberán seguir y aplicar las especificaciones del fabricante del vehículo.



Si tiene alguna pregunta, nuestro servicio de atención al cliente y nuestros distribuidores estarán encantados de prestarle ayuda. Encontrará nuestro número de teléfono y una lista de nuestros distribuidores en nuestra tienda online:

[www.sw-motech.com](http://www.sw-motech.com)



**Usar fijador de roscas:** Indica que una rosca debe recubrirse con fijador de roscas líquido. H (HIGH): resistencia alta; M (MEDIUM): resistencia media; L (LOW): resistencia baja.



**Respete la información del par de apriete:** Indica el par de apriete de una pieza especificada por SW-MOTECH o el fabricante del vehículo (OEM).

LISTA DE PIEZAS - LEE Y CONSERVA LAS INSTRUCCIONES DE MONTAJE!

1

1



HSK.00.745.025.35GR

 1/1

2



M6 x 14; ISO 7380  
SC.ST.06.014.02.7380.109

 2/2

3



GPT.00.152.035.02

 4/4

4



GPT.00.152.010.35

 2/2

5



M6 x 25; DIN 7991  
SC.ST.06.025.02.7991.088

 2/2

1

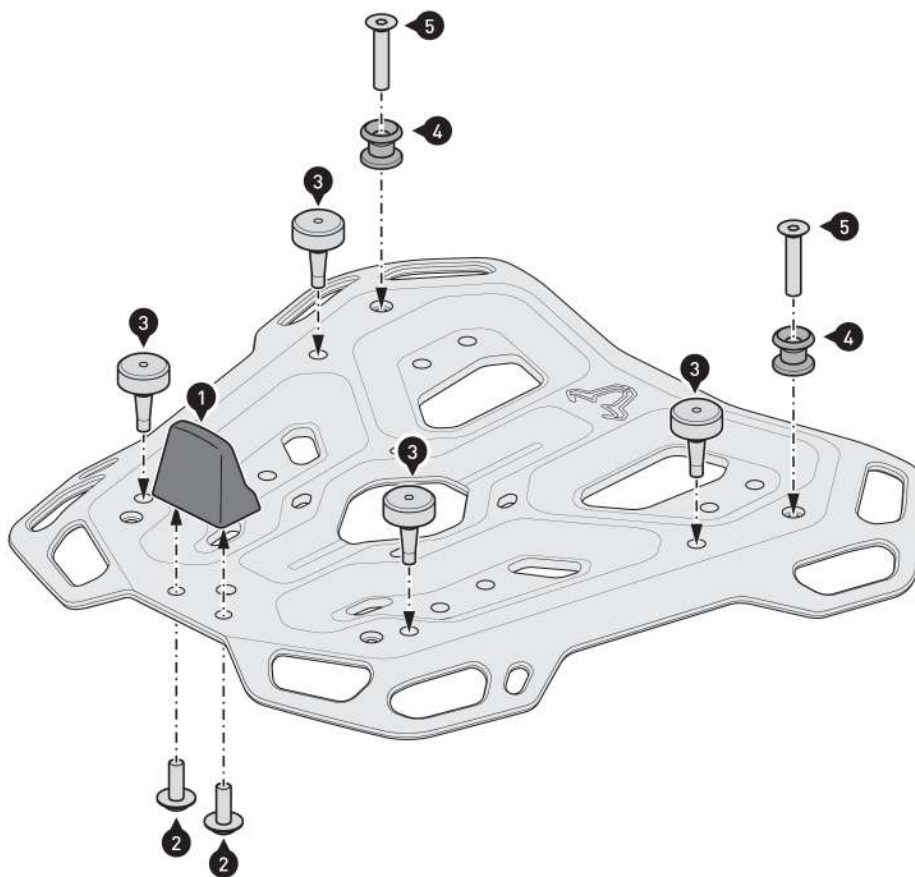

⚠ **ATENCIÓN:** ¡Use siempre protección de ojos y manos!  
 ⚠ **ATENCIÓN:** ¡Utilice siempre herramientas adecuadas!

Monte las piezas indicadas en el portaequipaje.

⚠ **ATENCIÓN:** ¡Utilice fijador de roscas líquido!

Apriete los tornillos tal y como se indica en las instrucciones de montaje.

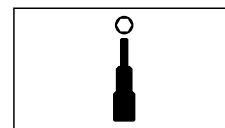
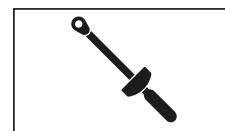
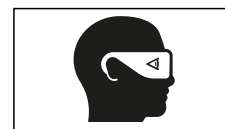

**INDICACIONES ESPECÍFICAS DEL PRODUCTO**

**⚠ NOTA:** *Tenga en cuenta las normas específicas del país para la matriculación/uso de su vehículo o las normas aplicables de la ITV. En caso de piezas con registro obligatorio, su organismo de inspección debe registrarlas tras el montaje en los documentos del vehículo.*

Numéro d'article: GPT.00.152.36200/B

Révision: 00 · Date: 08 - 2023

## Kit d'adaptation pour porte-bagages ADVENTURE-RACK

 ~ 0.25 h.

 FACILE     DIFFICILE

**FRANÇAIS** · Nous vous remercions d'avoir choisi ce produit haut de gamme de SW-MOTECH. Visitez notre boutique en ligne pour plus d'informations (par exemple affectation des modèles). Les documents nécessaires (par exemple ABE) y sont disponibles en téléchargement.

**Veillez lire et prendre en compte toutes les instructions, les consignes de sécurité et les avertissements contenus dans ce manuel de montage avant de monter et d'utiliser le produit afin d'éviter toute blessure ou tout dommage. Veuillez conserver la notice d'utilisation pour référence.**

**Ce produit a été développé pour des véhicules en configuration d'usine. Nous ne sommes pas en mesure d'assurer la compatibilité avec les pièces de rechange originales ou les pièces de rechange d'autres fabricants.**

**La présente notice d'installation a été élaborée conformément à nos connaissances actuelles. Il n'existe aucun droit juridique à l'exactitude des informations qu'elle contient. Sous réserve d'erreurs et de fautes. Sous réserve de modifications techniques et conceptuelles. SW-MOTECH détient les droits d'auteur.**

### SYMBOLE D'AVERTISSEMENT DE SÉCURITÉ

**⚠ Ce symbole d'avertissement est utilisé dans ces instructions de montage pour mettre en garde contre des dangers mortels, de blessures ou d'autres risques. Les mots DANGER, ATTENTION ou RECOMMANDATION sont utilisés avec ce symbole d'avertissement pour transmettre des consignes de sécurité et des informations importantes concernant le montage et l'utilisation de ce produit. Ces mots, associés au symbole d'avertissement de sécurité, signifient :**

**⚠ DANGER :** signale une situation dangereuse pouvant entraîner la mort ou des blessures graves si elle n'est pas évitée !

**⚠ ATTENTION :** signale une situation dangereuse pouvant entraîner la mort ou des blessures graves si elle n'est pas évitée !

**⚠ PRUDENCE :** Indique une situation dangereuse susceptible d'entraîner des blessures de gravité réduite ou moyenne si elle se présente !

**⚠ REMARQUE :** Informations importantes, mais qui n'entraînent pas de risque de décès ou de blessure (dommages matériels uniquement).

### REMARQUES GÉNÉRALES

**⚠ ATTENTION :** le montage et/ou l'entretien de ce produit nécessite des compétences techniques avancées, des outils appropriés et une bonne compréhension de l'utilisation des outils et des indications de réglage. Pour votre propre sécurité, SW-MOTECH recommande de confier le montage et/ou l'entretien à un atelier de réparation de deux-roues qualifié et certifié.

**⚠ ATTENTION :** si vous décidez de monter vous-même ce produit, lisez attentivement et intégralement les instructions de montage avant le montage et l'utilisation et suivez toutes les instructions afin d'éviter des blessures graves ou mortelles. Lors du montage et de l'utilisation, tenez également compte de toutes les informations pertinentes du manuel du véhicule. **SI VOUS NE COMPRENEZ PAS UNE PARTIE DE CE MANUEL D'INSTALLATION OU SI VOUS AVEZ BESOIN D'EXPLICATIONS CONCERNANT UNE INSTRUCTION, N'ESSAYEZ PAS D'INSTALLER CE PRODUIT SANS DEMANDER DE L'AIDE À SW-MOTECH !**

**PRÉPARATION :** Veuillez lire attentivement les instructions de montage et assurez-vous que tous les éléments de la liste de pièces sont présents.

**⚠ PRUDENCE :** veillez à ce que votre véhicule soit bien stable. Éteignez le moteur et retirez la clé de contact. Laissez refroidir le moteur/l'échappement si nécessaire. Débranchez la batterie lorsque vous travaillez sur le système électrique. Utilisez uniquement des outils appropriés et portez toujours des lunettes de protection et des gants pendant le montage et l'entretien. Faites-vous aider par une deuxième personne lors du montage et de l'entretien.

**MONTAGE :** Toutes les pièces et connexions retirées du véhicule doivent être réinstallées conformément aux instructions du fabricant du véhicule ou remplacées par des pièces et du matériel fournis par SW-MOTECH.

**⚠ ATTENTION** Sauf indication contraire, sécurisez tous les filetages avec du frein filet liquide de force moyenne.

**⚠ DANGER :** Les couples de serrage non définis par SW-MOTECH doivent être obtenus auprès du constructeur du véhicule ou d'un atelier de réparation de motos certifié.

**CONTRÔLE DU FONCTIONNEMENT :** Après le montage, assurez-vous qu'aucune pièce mobile n'est bloquée et que le fonctionnement du véhicule n'est pas perturbé. Les câbles et les tuyaux ne doivent pas frotter et/ou être coincés.

**⚠ ATTENTION :** Effectuez un contrôle de fonctionnement complet avant de commencer à rouler. Après les 50 premiers kilomètres, puis régulièrement, vérifiez le couple de serrage de tous les raccords et la bonne fixation du produit. Les accessoires montés peuvent modifier le comportement sur la route et la stabilité du véhicule.



SW-MOTECH GmbH & Co. KG  
Ernteweg 7-10  
35282 Rauschenberg  
Allemagne



✉ [info@sw-motech.com](mailto:info@sw-motech.com)  
🌐 [www.sw-motech.com](http://www.sw-motech.com)



Vous trouverez les symboles et leur signification dans la section MONTAGE. Si le terme OEM apparaît dans la section MONTAGE, il faut respecter et appliquer les consignes du fabricant du véhicule.



Si vous avez des questions, notre service clientèle ainsi que nos distributeurs se tiennent à votre disposition. Vous trouverez notre numéro de téléphone ainsi que la liste de nos distributeurs sur notre boutique en ligne : [www.sw-motech.com](http://www.sw-motech.com)



**Utilisez du frein filet :** Indique qu'un filetage doit être enduit de frein filet liquide. H (HIGH) : haute résistance ; M (MEDIUM) : force moyenne ; L (LOW) : faible résistance.



**Serrer en respectant les instructions de couple de serrage :** indique le couple de serrage d'une pièce prescrit par SW-MOTECH ou par le fabricant du véhicule (OEM).



LISTE DES PIÈCES - LIRE ET CONSERVER LES INSTRUCTIONS DE MONTAGE!

1

1



HSK.00.745.025.35GR

 1/1

2



M6 x 14; ISO 7380  
SC.ST.06.014.02.7380.109

 2/2

3



GPT.00.152.035.02

 4/4

4



GPT.00.152.010.35

 2/2

5



M6 x 25; DIN 7991  
SC.ST.06.025.02.7991.088

 2/2

1

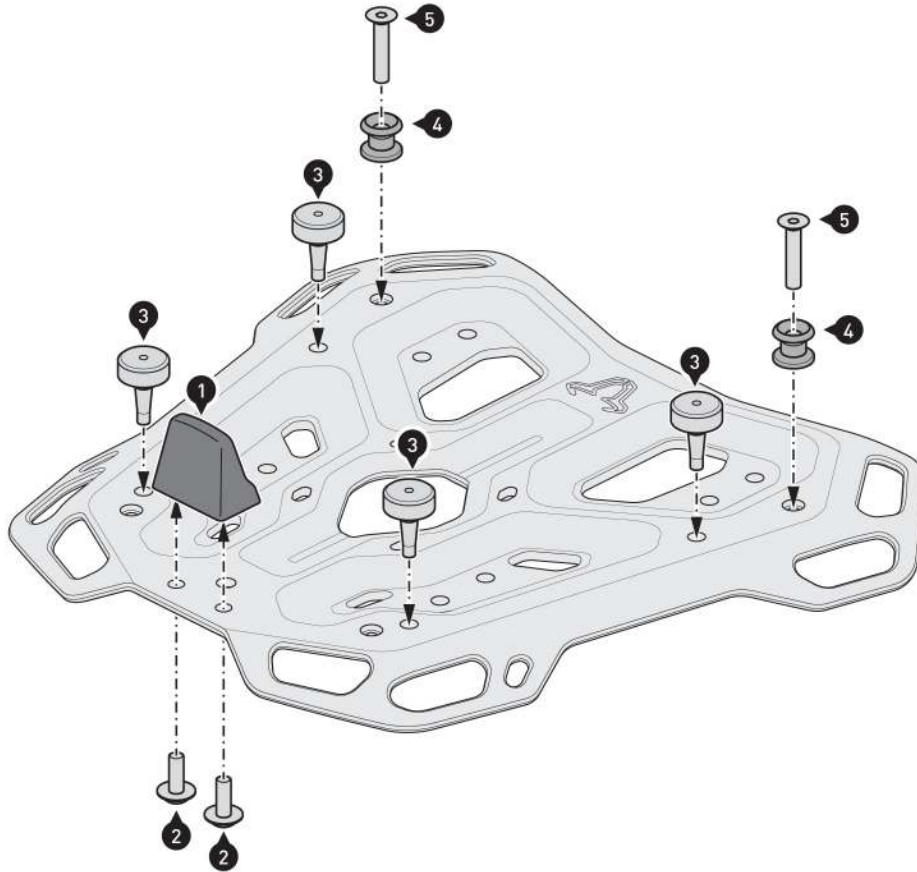

⚠ ATTENTION : portez toujours des lunettes et des gants de protection !  
 ⚠ ATTENTION : Utilisez toujours des outils appropriés !

Montez les pièces indiquées sur votre porte-bagages.

⚠ ATTENTION : utilisez du frein filet liquide !

Serrez les vis comme indiqué dans les instructions de montage.

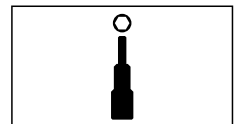
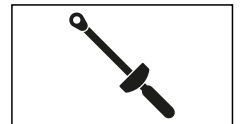
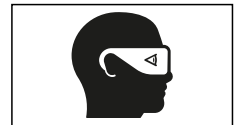

**REMARQUES SPÉCIFIQUES AU PRODUIT**

**⚠ REMARQUE** : Respectez les réglementations spécifiques au pays pour l'immatriculation/l'exploitation de votre véhicule ou les réglementations TÜV applicables. Après le montage, faites inscrire les pièces soumises à immatriculation dans les papiers du véhicule par votre centre de contrôle.

Numero di articolo: GPT.00.152.36200/B

Revisione: 00 · Data: 08 - 2023

**Kit adattatore per portabagagli ADVENTURE-RACK** ~ 0.25 h.FACILE     DIFFICILE

**ITALIANO** -Grazie per aver scelto questo prodotto premium di SW-MOTECH. Visita il nostro negozio online per ulteriori informazioni (ad es. per la compatibilità con i vari modelli). I documenti richiesti (ad es. certificato di omologazione nazionale) possono essere scaricati qui.

**Si prega di leggere attentamente le avvertenze di sicurezza e le istruzioni per il montaggio prima di montare e utilizzare il prodotto, al fine di evitare eventuali lesioni e danni. Conserva queste istruzioni per il montaggio come riferimento futuro.**

**Questo prodotto è stato sviluppato per veicoli in condizioni di fabbrica. La compatibilità con gli accessori originali o di altri produttori non può essere garantita.**

**Queste istruzioni per il montaggio sono state redatte in base alle nostre conoscenze attuali. Non sussistono pretese di correttezza giuridiche. Salvo errori ed omissioni. Ci riserviamo il diritto di apportare modifiche tecniche e di design. Copyright SW-MOTECH.**

**SIMBOLO DI SICUREZZA**

 Questo simbolo di avvertenza è usato nelle presenti istruzioni di montaggio per segnalare pericoli mortali, rischio di lesioni o altri pericoli. Le parole "PERICOLO", "AVVERTENZA" O "ATTENZIONE" sono utilizzate con questo simbolo di avvertenza per trasmettere importanti istruzioni di sicurezza e informazioni relative al montaggio e all'uso di questo prodotto. Queste parole, utilizzate insieme al simbolo di avvertenza, significano:

**▲ PERICOLO:** indica una situazione di pericolo che, se non evitata, può causare morte o lesioni gravi!

**▲ AVVERTENZA:** indica una situazione di pericolo che, se non evitata, può causare morte o lesioni gravi!

**▲ ATTENZIONE:** indica una situazione di pericolo che, se non evitata, può provocare lesioni lievi o di entità moderata!

**▲ AVVISO:** indica informazioni importanti che non riguardano il rischio di morte o di lesioni (riguardano unicamente il rischio di danni materiali)!

**INFORMAZIONI GENERALI**

**▲ AVVERTENZA:** il montaggio e/o la manutenzione di questo prodotto richiedono competenze tecniche avanzate, strumenti adeguati e una buona conoscenza dell'uso della strumentazione e delle indicazioni relative alle coppie di serraggio. Per ragioni di sicurezza, SW-MOTECH raccomanda di far eseguire il montaggio e/o la manutenzione presso un'officina per motociclette qualificata e certificata.

**▲ AVVERTENZA:** se si decide di installare questo prodotto in autonomia, leggere attentamente le istruzioni per il montaggio prima del montaggio e dell'uso e seguire tutte le avvertenze per evitare lesioni gravi o mortali. Durante il montaggio e l'uso, seguire anche tutte le istruzioni pertinenti contenute nel manuale del veicolo. **SE NON SI COMPRENDONO TALI ISTRUZIONI, ANCHE SOLO IN PARTE, O SE SONO NECESSARI CHIARIMENTI, NON CERCARE DI MONTARE IL PRODOTTO IN AUTONOMIA SENZA CHIEDERE IL SUPPORTO DI SW-MOTECH!**

**PREPARAZIONE:** leggere attentamente le istruzioni per il montaggio e assicurarsi che siano disponibili tutti i componenti contenuti nella lista.

**▲ ATTENZIONE:** assicurarsi che il veicolo sia perfettamente fermo. Spegnerne il motore e togliere la chiave. Se necessario, lasciar raffreddare il motore/lo scarico. Scollegare la batteria quando si interviene sull'impianto elettrico. Usare esclusivamente strumenti idonei e indossare sempre occhiali e guanti protettivi durante le operazioni di montaggio e manutenzione. Chiedere aiuto a una seconda persona durante le fasi di montaggio e manutenzione.

**MONTAGGIO:** tutti i componenti e i collegamenti rimossi dal veicolo devono essere reinstallati secondo le specifiche del produttore del veicolo o sostituiti con componenti e attrezzatura forniti da SW-MOTECH.

**▲ AVVERTENZA:** fissare tutte le filettature con frenafili liquido a media resistenza, se non diversamente specificato.

**▲ PERICOLO:** le coppie di serraggio non definite da SW-MOTECH devono essere richieste al costruttore del veicolo o a un'officina certificata.

**CONTROLLO DI FUNZIONALITÀ:** dopo il montaggio accertarsi che non vi siano parti mobili bloccate e che il funzionamento del veicolo non sia compromesso. I cavi e i tubi flessibili non devono sfregare e/o essere schiacciati.

**▲ AVVERTENZA:** eseguire un controllo completo delle funzioni prima di mettersi alla guida. Controllare la coppia di serraggio di tutti i collegamenti e la tenuta del prodotto dopo i primi 50 km e in seguito regolarmente. Gli accessori montati possono modificare la maneggevolezza e la stabilità del veicolo.



SW-MOTECH GmbH & Co. KG  
Ernteweg 7-10  
35282 Rauschenberg  
Germania



info@sw-motech.com  
www.sw-motech.com



Consultare i simboli e il loro significato nella sezione MONTAGGIO. Se nella sezione montaggio compare la sigla OEM, è necessario rispettare e applicare le specifiche del produttore del veicolo.



Per qualsiasi domanda, non esitare a contattare il nostro servizio clienti o i nostri distributori. Il nostro numero di telefono e l'elenco dei nostri distributori sono disponibili nel nostro negozio online:

**[www.sw-motech.com](http://www.sw-motech.com)**



**Usare un frenafiletto:** indica che la filettatura deve essere rivestita con un frenafiletto liquido. H (ALTA): alta resistenza; M (MEDIA): media resistenza; L (BASSO): bassa resistenza.



**Serraggio / rispetto delle specifiche sulla coppia di serraggio:** indica la coppia di serraggio di un componente specificata da SW-MOTECH o dal produttore del veicolo (OEM).

ELENCO DELLE PARTI - LEGGI E CONSERVA LE ISTRUZIONI DI MONTAGGIO!

1



HSK.00.745.025.35GR  
 1/1



M6 x 14; ISO 7380  
 SC.ST.06.014.02.7380.109  
 2/2



GPT.00.152.035.02  
 4/4

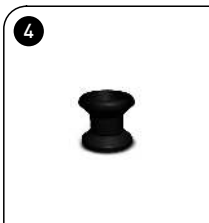

GPT.00.152.010.35  
 2/2



M6 x 25; DIN 7991  
 SC.ST.06.025.02.7991.088  
 2/2

1

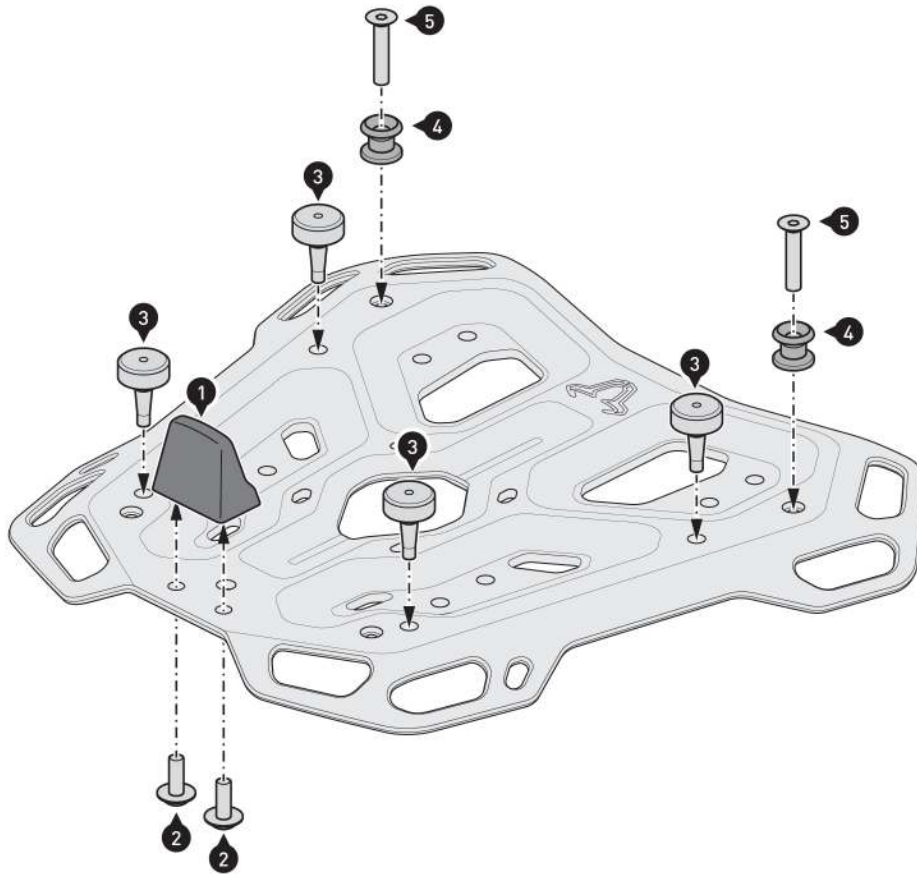

**⚠ AVVERTENZA: indossare sempre le protezioni per gli occhi e per le mani!**  
**⚠ AVVERTENZA: Utilizzare sempre strumenti adeguati!**

Montare le parti mostrate sul portabagagli.

**⚠ AVVERTENZA: Usare un frenafilietti liquido!**



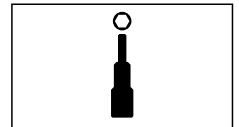
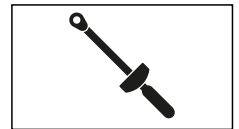
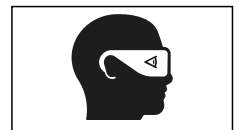

Serrare le viti come indicato nelle istruzioni per il montaggio.



**AVVERTENZE SPECIFICHE DEL PRODOTTO**

**⚠ AVVISO** :Rispettare le normative specifiche del paese per l'immatricolazione/l'uso del veicolo o le normative TÜV applicabili. Dopo il montaggio, far inserire le parti soggette a omologazione nei documenti del veicolo dal proprio centro di test.



Art.-Nr.: <b>HSK.00.745.11000/B</b>	Revision: <b>02</b> · Datum: <b>08 - 2023</b>
<b>DUSC L</b>	
🕒 ~ 0.25 h.	LEICHT     SCHWER

**DEUTSCH** - Vielen Dank, dass Sie sich für dieses Premium-Produkt von SW-MOTECH entschieden haben. Besuchen Sie unseren Webshop für weitere Informationen (z. B. Modellzuweisungen). Erforderliche Dokumente (z. B. ABE) stehen Ihnen dort als Download zur Verfügung.

Bitte lesen und verstehen Sie alle Anweisungen, Sicherheitshinweise und Warnungen in dieser Anbauanleitung vor Montage und Nutzung des Produkts, um Verletzungen und Schäden zu vermeiden. Bewahren Sie diese Anbauanleitung als Referenz auf.

Dieses Produkt wurde für Fahrzeuge im Werkzustand entwickelt. Die Kompatibilität mit Original-Zubehörteilen bzw. den Zubehörteilen anderer Hersteller kann nicht gewährleistet werden.

Diese Anbauanleitung ist nach unserem derzeitigen Kenntnisstand verfasst worden. Rechtliche Ansprüche auf Richtigkeit bestehen nicht. Fehler und Irrtümer vorbehalten. Technische und gestalterische Änderungen sind vorbehalten. Das Urheberrecht liegt bei SW-MOTECH.

**SICHERHEITSWARNUNGSSYMBOL**

⚠️ Dieses Warnsymbol wird in dieser Anbauanleitung verwendet, um vor tödlichen Gefahren, Verletzungen oder anderen Gefahren zu warnen. Die Wörter **GEFAHR**, **WARNUNG** oder **VORSICHT** werden mit diesem Warnsymbol verwendet, um wichtige Sicherheitshinweise und Informationen in Bezug auf die Montage und Nutzung dieses Produkts zu übermitteln. Diese Wörter zusammen mit dem Sicherheitswarnsymbol bedeuten:

▲ **GEFAHR:** Weist auf eine gefährliche Situation hin, die zum Tod oder zu schweren Verletzungen führt, wenn sie nicht vermieden wird!

▲ **WARNUNG:** Weist auf eine gefährliche Situation hin, die zum Tod oder zu schweren Verletzungen führen kann, wenn sie nicht vermieden wird!

▲ **VORSICHT:** Weist auf eine gefährliche Situation hin, die zu leichten oder mittelschweren Verletzungen führen kann, wenn sie nicht vermieden wird!

⚠️ **HINWEIS:** Wichtige Informationen, jedoch nicht in Bezug auf Todes- oder Verletzungsgefahr (nur Sachschäden)!

**ALLGEMEINE HINWEISE**

▲ **WARNUNG:** Die Montage und/oder Wartung dieses Produkts erfordert fortgeschrittene technische Fähigkeiten, geeignetes Werkzeug und ein gutes Verständnis der Werkzeugnutzung und Drehmomentangaben. Zu Ihrer eigenen Sicherheit empfiehlt SW-MOTECH, die Montage und/oder Wartung von einer qualifizierten und zertifizierten Zweiradwerkstatt durchführen zu lassen.

▲ **WARNUNG:** Wenn Sie sich für die Eigenmontage dieses Produkts entscheiden, lesen Sie vor Montage und Nutzung die Anbauanleitung sorgfältig und vollständig durch und befolgen Sie alle Anweisungen, um schwere oder tödliche Verletzungen zu vermeiden. Beachten Sie bei der Montage und Verwendung auch alle relevanten Informationen im Fahrzeughandbuch. **WENN SIE EINEN TEIL DIESER ANBAUANLEITUNG NICHT VERSTEHEN ODER EINE ERKLÄRUNG EINER ANWEISUNG BENÖTIGEN, VERSUCHEN SIE NICHT DIESES PRODUKT ZU MONTIEREN, OHNE SW-MOTECH UM HILFE ZU FRAGEN!**

**VORBEREITUNG:** Lesen Sie die Anbauanleitung aufmerksam und stellen Sie sicher, dass alle Teile der Stückliste vorhanden sind.

▲ **VORSICHT:** Achten Sie auf den sicheren Stand Ihres Fahrzeugs. Schalten Sie den Motor ab und ziehen Sie den Zündschlüssel. Lassen Sie den Motor/Auspuff bei Bedarf abkühlen. Klemmen Sie die Batterie bei Arbeiten an der Elektrik ab. Verwenden Sie nur geeignetes Werkzeug und tragen Sie während der Montage und Wartung immer eine Schutzbrille und Handschuhe. Lassen Sie sich bei der Montage und Wartung von einer zweiten Person helfen.





**MONTAGE:** Alle vom Fahrzeug entfernten Teile und Verbindungen müssen gemäß den Angaben des Fahrzeugherstellers wieder eingebaut oder durch von SW-MOTECH gelieferte Teile und Hardware ersetzt werden.

▲ **WARNUNG:** Sichern Sie alle Gewinde, sofern nicht anders angegeben, mit mittelstarker, flüssiger Schraubensicherung.

▲ **GEFAHR:** Von SW-MOTECH nicht definierte Anzugsdrehmomente müssen Sie vom Fahrzeughersteller oder von einer zertifizierten Motorradwerkstatt beziehen.

**FUNKTIONSKONTROLLE:** Stellen Sie nach der Montage sicher, dass keine beweglichen Teile blockiert sind und die Funktion des Fahrzeugs nicht gestört wird. Kabel und Schläuche dürfen nicht scheuern und/oder geklemmt werden.

▲ **WARNUNG:** Führen Sie vor Fahrtbeginn eine umfassende Funktionskontrolle durch. Prüfen Sie nach den ersten 50 km und dann regelmäßig das Anzugsmoment aller Verbindungen und den festen Sitz des Produkts. Montiertes Zubehör kann das Fahrverhalten und die Stabilität des Fahrzeugs verändern.

	<p><b>SW-MOTECH GmbH &amp; Co. KG</b> Ernteweg 7-10 35282 Rauschenberg Deutschland</p>	   
	<p>info@sw-motech.com www.sw-motech.com</p>	



Beachten Sie in dem Abschnitt MONTAGE vorkommenden Symbole und deren Bedeutung. Wenn im Abschnitt MONTAGE die Bezeichnung OEM vorkommt, müssten die Vorgaben des Fahrzeugherstellers beachtet und angewandt werden.



Bei Fragen steht Ihnen unser Kundendienst sowie unsere Distributoren gerne zur Verfügung. Unsere Telefonnummer sowie eine Liste unserer Distributoren finden Sie in unserem Webshop: [www.sw-motech.com](http://www.sw-motech.com)



**Keine Schraubensicherung verwenden:** Weist darauf hin, dass an der Stelle keine flüssige Schraubensicherung notwendig ist.



**Handfest anziehen:** Weist darauf hin, dass das Anbauteil vorsichtig mit der Hand angezogen werden muss.

1

1



HSK.00.745.80000/B

 1/1

2

2



HSK.00.745.027.02

 2/2

3

3



HSK.00.745.047.02

 1/1

4



4 x 10; WN 1452  
SC.ST.040.010.48.1452.109

 2/2

5



T20  
TRX.T20

 1/1

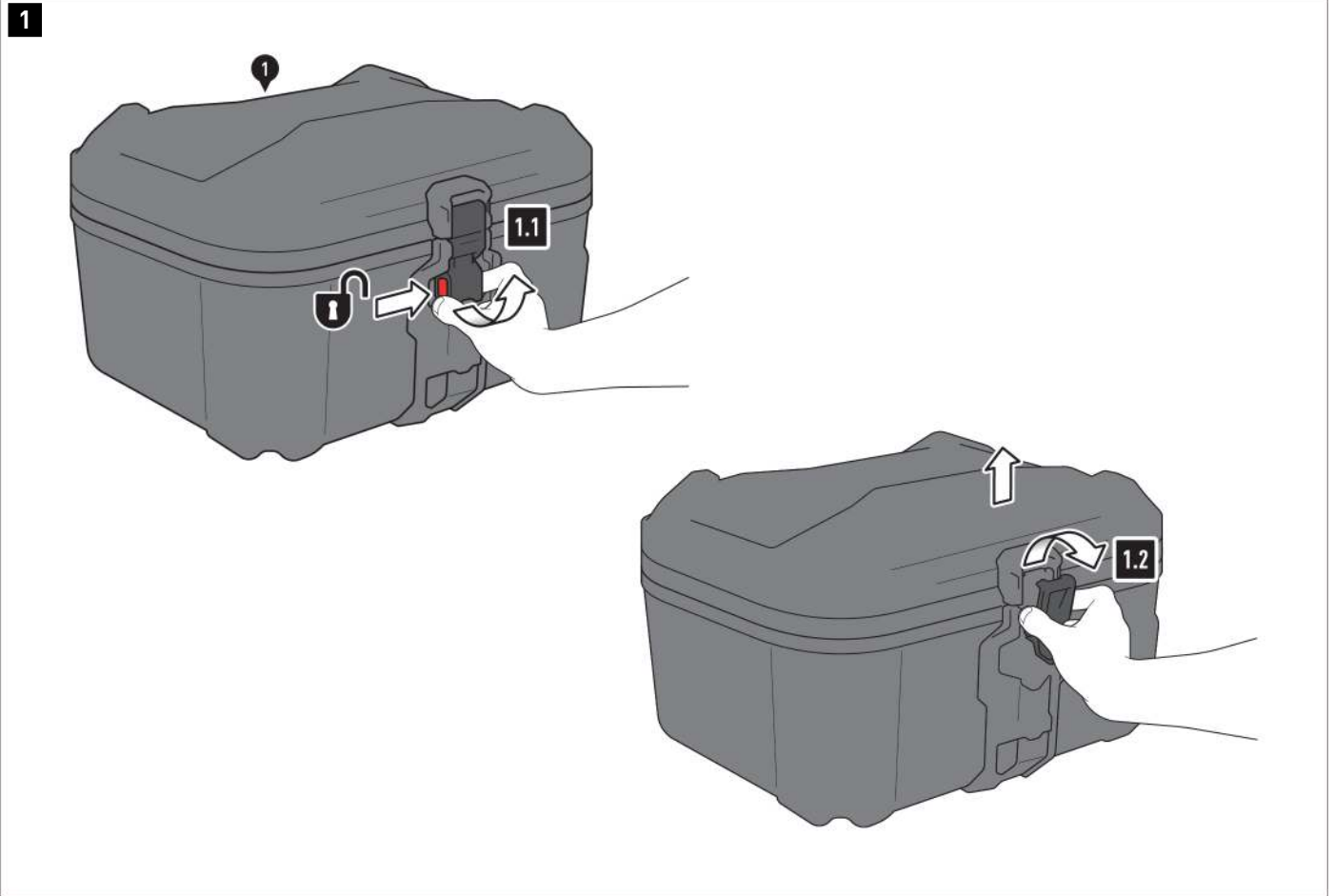

**▲ WARNUNG: Tragen Sie immer Augen- und Handschutz!**  
**▲ WARNUNG: Verwenden Sie immer geeignetes Werkzeug!**

**Öffnen des Deckels**

**1.1** - Drücken Sie den Entriegelungsknopf des DUSC (1) und ziehen Sie den Spannverschluss des Deckels in die offene Position.

**1.2** - Entfernen Sie den Spannverschluss vom Spannverschlussbügel und öffnen Sie den Deckel.

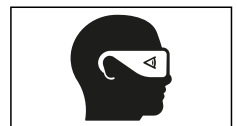

2

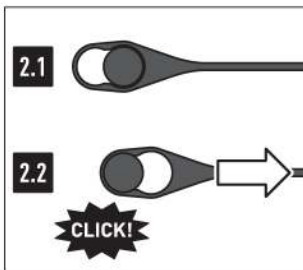
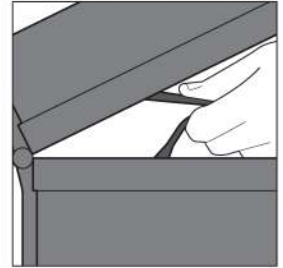
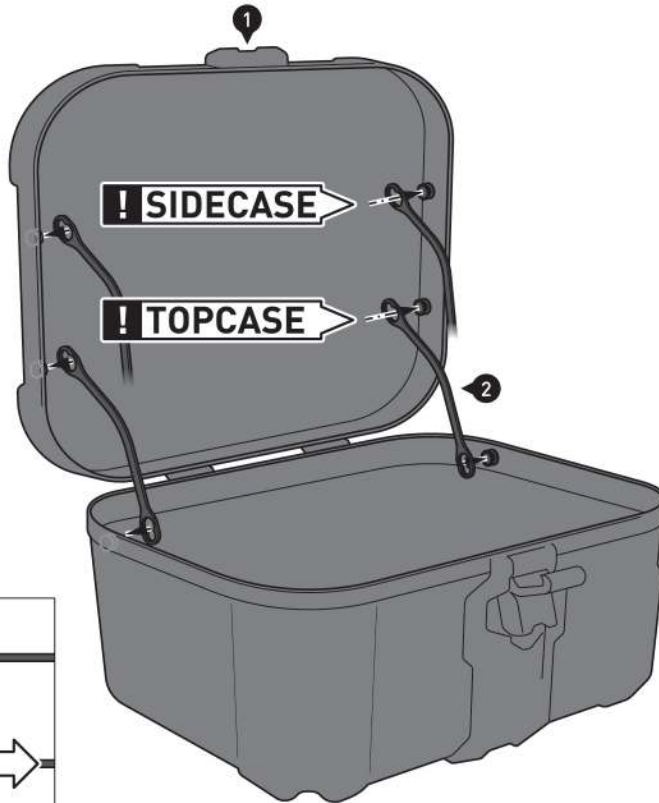

**Montage der Deckelbegrenzer**

2.1 - Stecken Sie die Deckelbegrenzer [2] mit den großen Öffnungen auf die dafür vorgesehenen Haltepilze

**⚠ HINWEIS:** Achten Sie auf den Verwendungszweck des DUSC (1): **Topcase** oder **Sidecase**. Befestigen Sie die Deckelbegrenzer [2] an den jeweiligen Haltepilzen des DUSC (1).

2.2 - Ziehen Sie die Deckelbegrenzer [2] in die Befestigungsposition.

**⚠ HINWEIS:** Vor dem ersten Verschluss des Deckels müssen die Deckelbegrenzer [2] ein wenig gestaucht werden. Achten Sie beim Schließen des Deckels darauf, dass die Deckelbegrenzer [2] nicht zwischen Deckel und Korpus geklemmt werden.

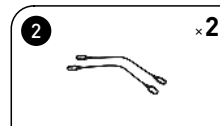



**Verschlussgehäusestecker verbauen**

**⚠ HINWEIS:** Falls Sie sich für den Schloss-Satz für DUSC entschieden haben, entfällt dieser Montageschritt. Montieren Sie stattdessen den Schloss-Satz.

**3.1 -** Öffnen Sie den Spannverschluss des DUSC (1) und positionieren Sie den Verschlussgehäusestecker (3) wie gezeigt.

**⚠ HINWEIS:** Stellen Sie sicher, dass sich die Schließblase in der entriegelten Position befindet (oben)! Gegebenenfalls muss die Schließblase nach oben in die entriegelte Position gedrückt werden!

**3.2 -** Drücken Sie den Verschlussgehäusestecker (3) nach unten, bis dieser einrastet.

**3.3 -** Verschrauben Sie den Verschlussgehäusestecker (3) mit den Schrauben (4) und dem Torxschlüssel (5). Ziehen Sie die Schrauben vorsichtig und handfest an.

**⚠ WARNUNG:** Ein zu festes Anziehen der Schrauben kann das Schlossgehäuse beschädigen!

**⚠ HINWEIS:** Überprüfen Sie die Funktion des Verriegelungsmechanismus!



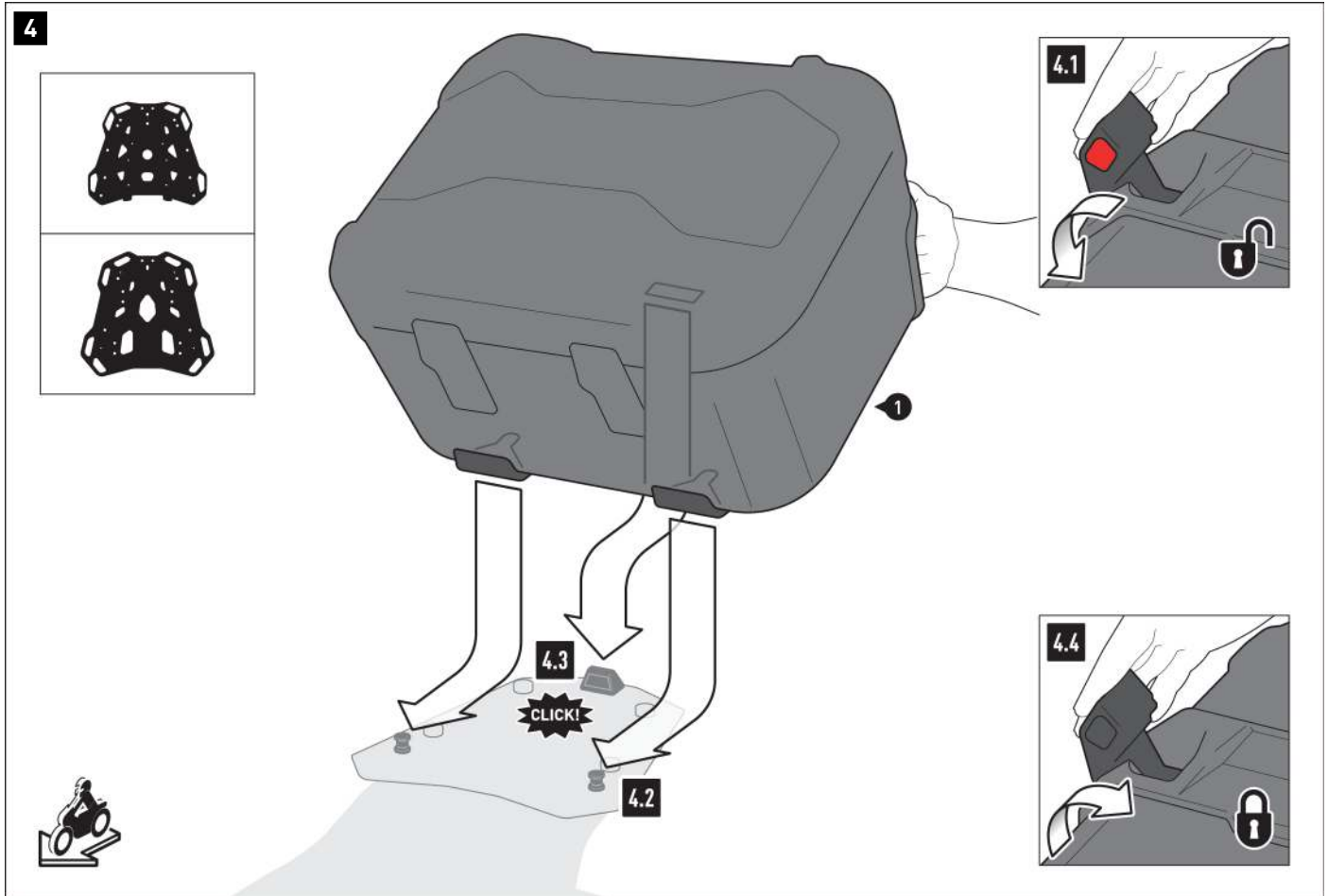

#### Befestigung des DUSC als Topcase

**4.1** - Drücken Sie den Entriegelungsknopf des DUSC (1) und ziehen Sie den Spannverschluss des Verriegelungssystems in die offene Position.

**4.2** - Drücken Sie den DUSC (1) mit den beiden Arretierungsöffnungen auf die Haltepilze Ihres SW-MOTECH Gepäckträgers.

**4.3** - Drücken Sie den DUSC (1) mit der Verriegelungsöffnung auf die Schlossnase Ihres SW-MOTECH Gepäckträgers.

**▲ WARNUNG: Achten Sie auf das hörbare Einrastgeräusch!**

**4.4** - Drücken Sie den Spannverschluss des Verriegelungssystems in die geschlossene Position.

**▲ WARNUNG: Überprüfen Sie den festen Sitz des DUSC!**

**▲ WARNUNG: Achten Sie darauf, dass keine Komponenten des DUSC (1) mit heißen und beweglichen Teilen des Fahrzeugs in Kontakt kommen können! Achten Sie des Weiteren darauf, dass alle Komponenten mindestens 5 cm Abstand zu heißen Teilen sowie dem heißen Abgasstrom des Auspuffs haben!**

**Stellen Sie nach der Montage sicher, dass dieser Abstand in jedem Federzustand des Fahrzeugs eingehalten wird!**

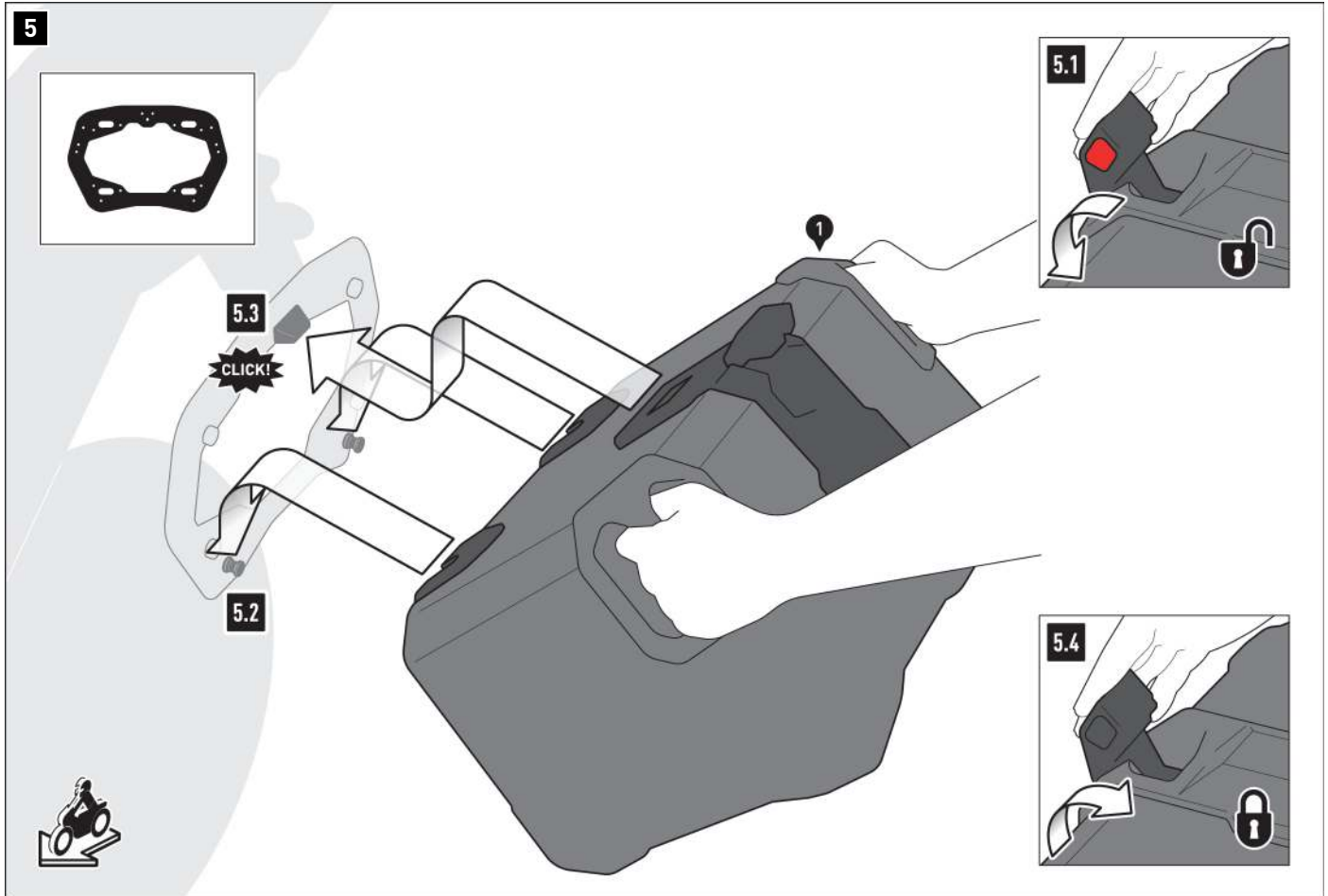

#### Befestigung des DUSC als Sidecase

**5.1** - Drücken Sie den Entriegelungsknopf des DUSC (1) und ziehen Sie den Spannverschluss des Verriegelungssystems in die offene Position.

**5.2** - Drücken Sie den DUSC (1) mit den beiden Arretieröffnungen auf die Haltepilze Ihres SW-MOTECH Seitenträgers.

**5.3** - Drücken Sie den DUSC (1) mit der Verriegelungsöffnung auf die Schlossnase Ihres SW-MOTECH Seitenträgers.

**▲ WARNUNG: Achten Sie auf das hörbare Einrastgeräusch!**

**5.4** - Drücken Sie den Spannverschluss des Verriegelungssystems in die geschlossene Position.

**▲ WARNUNG: Überprüfen Sie den festen Sitz des DUSC!**

**▲ WARNUNG: Achten Sie darauf, dass keine Komponenten des DUSC (1) mit heißen und beweglichen Teilen des Fahrzeugs in Kontakt kommen können! Achten Sie des Weiteren darauf, dass alle Komponenten mindestens 5 cm Abstand zu heißen Teilen sowie dem heißen Abgasstrom des Auspuffs haben!**

**Stellen Sie nach der Montage sicher, dass dieser Abstand in jedem Federzustand des Fahrzeugs eingehalten wird!**



6

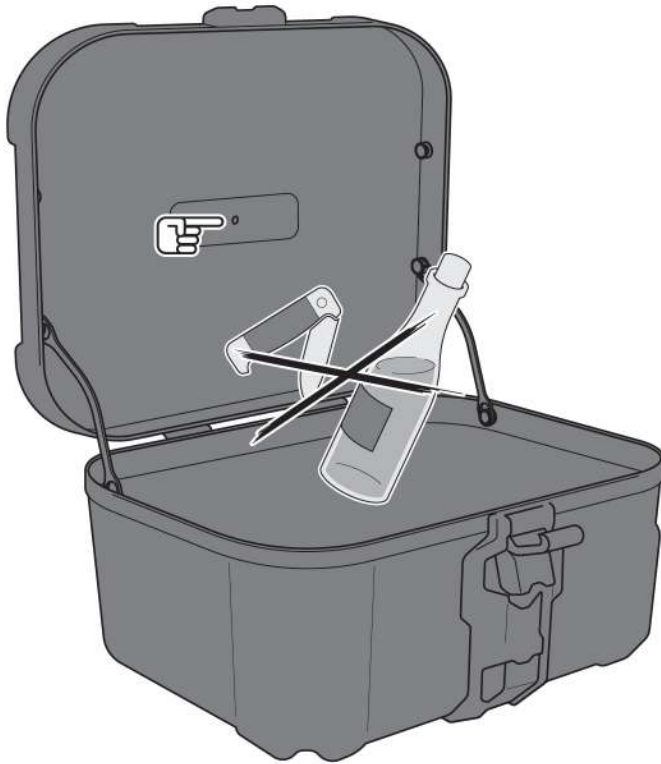

**Beladung**

**⚠️ WARNUNG:** Achten Sie auf die gleichmäßige Verteilung der Ladung! Stellen Sie sicher, dass die Ladung während der Fahrt gegen Verrutschen gesichert ist!

**⚠️ HINWEIS:** Achten Sie darauf, niemals scharfkantige, spitze oder ähnliche Gegenstände zu verstauen, welche Verletzungen an Personen bzw. Beschädigungen am Fahrzeug/DUSC verursachen könnten! Achten Sie besonders darauf, die in den Deckel integrierte Überdruckmembran nicht zu beschädigen!

**Pflege**

Verwenden Sie zur Reinigung NUR eine weiche Textilbürste, ein Tuch oder Schwamm und warme Seifenlauge! Spülen Sie anschließend mit klarem Wasser nach.

Verwenden Sie KEINE scharfen Reinigungsmittel, raue Putzutensilien oder einen Hochdruckreiniger! Reinigen Sie den DUSC unbedingt nach Winterfahrten, um Schäden durch das Salz zu vermeiden.

**⚠️ HINWEIS:** Oberflächenmaterialien können bei längerer und intensiver Sonneneinstrahlung und Umwelteinflüssen (z. B. SMOG, saurer Regen, etc.) Farbveränderungen (Ausbleichen) unterliegen! Dafür übernimmt SW-MOTECH keine Haftung!

**PRODUKTSPEZIFISCHE HINWEISE**

**▲ HINWEIS:** Beachten Sie die landesspezifischen Vorschriften für Zulassung/Betrieb Ihres Fahrzeugs bzw. anwendbare TÜV-Vorschriften. Lassen Sie eintragungspflichtige Teile nach Montage durch Ihre Prüfstelle in die Fahrzeugpapiere eintragen.

**▲ GEFAHR:** Führen Sie vor Fahrtbeginn eine umfassende Funktionskontrolle durch!

**▲ GEFAHR:** Überprüfen Sie vor Fahrtbeginn und bei jeder Rast (alle 200 km) den ordnungsgemäßen Sitz des Produkts!

**▲ GEFAHR:** Das Fahr-/Bremsverhalten des Motorrads verändert sich nach Befestigung dieses Produkts merklich!

**▲ GEFAHR:** Die Schräglagen- und Bodenfreiheit kann durch dieses Produkt eingeschränkt werden!

**▲ GEFAHR:** Es gilt die vom Fahrzeughersteller genannte maximale Zuladung des Fahrzeugs!



≤ 10 KG (≤ 22 lbs)



≤ 130 km/h (≤ 80mph)

Item number: **HSK.00.745.11000/B**

Revision: **02** · Date: **08 - 2023**

## DUSC L

 ~ 0.25 h.

EASY      DIFFICULT

**ENGLISH** · Thank you for choosing this premium product from SW-MOTECH. Visit our online shop for more information (e.g. model assignments). Required documents (e.g. national type approval) are available there for you to download.

**Please read and understand all the instructions, safety information and warnings in these mounting instructions before mounting and using the product in order to avoid injury and damage. Keep these mounting instructions for reference.**

**This product was developed for vehicles in factory condition. Compatibility with original accessories or accessories from other manufacturers cannot be guaranteed.**

**These mounting instructions have been prepared to the best of our current knowledge. No legal claims relating to accuracy can be made. Errors and omissions excepted. We reserve the right to make technical and design changes. The copyright is held by SW-MOTECH.**

### SAFETY WARNING SYMBOL

 This warning symbol is used in these mounting instructions to warn of deadly dangers, injuries or other hazards. The words **DANGER, WARNING or CAUTION** are used as part of this warning symbol to convey important safety messages and information relating to the installation and use of this product. These words, together with the safety warning symbol, mean:

 **DANGER:** Indicates a hazardous situation which, if not avoided, will result in death or serious injury!

 **WARNING:** Indicates a hazardous situation which, if not avoided, may result in death or serious injury!

 **CAUTION:** Indicates a hazardous situation which, if not avoided, may result in minor or moderate injury!

 **NOTE:** Important information, but not relating to a risk of death or injury (property damage only)!

### GENERAL INFORMATION

 **WARNING:** Assembly and/or maintenance of this product requires advanced technical skill, appropriate tools, and a good understanding of tool usage and torque specifications. For your own safety, SW-MOTECH recommends having the assembly and/or maintenance carried out by a qualified and certified motorcycle workshop.

 **WARNING:** If you do choose to assemble this product yourself, carefully and fully read the mounting instructions before assembly and use, and follow all instructions to avoid serious injury or death. Also observe all relevant information in the vehicle manual when mounting or using the product. **IF YOU DO NOT UNDERSTAND ANY PART OF THESE MOUNTING INSTRUCTIONS OR NEED AN EXPLANATION AS TO A SPECIFIC INSTRUCTION, DO NOT ATTEMPT TO INSTALL THIS PRODUCT WITHOUT CONSULTING SW-MOTECH FOR ASSISTANCE!**

**PREPARATION:** Read the mounting instructions carefully and make sure that all parts on the parts list are available.

 **CAUTION:** Ensure that your vehicle is standing securely. Switch off the engine and remove the ignition key. Allow the engine/exhaust to cool down if necessary. Disconnect the battery when working on the electrical system. Only use proper tools and always wear safety goggles and gloves during assembly and maintenance. Have a second person help you with assembly and maintenance.

**ASSEMBLY:** All parts and connections removed from the vehicle must be reinstalled according to the vehicle manufacturer's specifications or replaced with parts and hardware supplied by SW-MOTECH.

 **WARNING:** Secure all threads with a medium-strength liquid threadlocker, unless otherwise specified.

 **DANGER:** Tightening torques not defined by SW-MOTECH must be obtained from the vehicle manufacturer or a certified motorbike workshop.

**FUNCTIONAL CHECK:** After mounting the product, ensure that no moving parts are obstructed and that the function of the vehicle is not impeded. Cables and hoses must not rub against each other and/or be hindered in any way.

 **WARNING:** Carry out a comprehensive functionality check before you start to drive. Check the tightening torque of all connections and the tight fit of the product after the first 50 km and then at regular intervals. Mounted accessories can change the handling and stability of the vehicle.



**SW-MOTECH GmbH & Co. KG**  
Ernteweg 7-10  
35282 Rauschenberg  
Germany



 [info@sw-motech.com](mailto:info@sw-motech.com)  
 [www.sw-motech.com](http://www.sw-motech.com)

**LEGEND OVERVIEW - READ AND KEEP MOUNTING INSTRUCTIONS!**



Take note of the symbols and what they mean in the ASSEMBLY section. If the term OEM appears in the ASSEMBLY section, the vehicle manufacturer's specifications must be observed and applied.



If you have any questions, please don't hesitate to contact our Customer Service team or our distributors. You can find our telephone number and a list of our distributors in our online shop:  
**[www.sw-motech.com](http://www.sw-motech.com)**



**Do not use thread lock:** Indicates that no liquid thread lock should be used at this point.



**Tighten by hand:** Indicates that the attachment must be carefully tightened by hand.

**PARTS LIST - READ AND KEEP MOUNTING INSTRUCTIONS!**

**1**

**1**



HSK.00.745.80000/B

 **1/1**

**2**

**2**



HSK.00.745.027.02

 **2/2**

**3**

**3**



HSK.00.745.047.02

 **1/1**

**4**



4 x 10; WN 1452  
SC.ST.040.010.48.1452.109

 **2/2**

**5**



T20  
TRX.T20

 **1/1**



**▲ WARNING: Always wear eye and hand protection!**  
**▲ WARNING: Always use the proper tools!**

**Opening the lid**

**1.1** - Press the DUSC release button (1) and pull the lid latch buckle to the open position.

**1.2** - Remove the latch buckle from the corresponding bracket and open the lid.

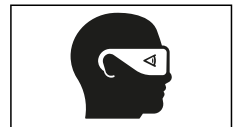

2



**Installing the lid limiter**

**2.1** - Place the lid limiters (2) with the large openings on the mushroom-shaped supports provided

**⚠ NOTE:** Pay attention to the proper use of the DUSC (1): **top case** or **side case**. Fasten the lid limiters (2) to the respective mushroom-shaped DUSC (1).

**2.2** - Pull the lid limiters (2) into fixed position.

**⚠ NOTE:** Before closing the lid for the first time, the lid limiters (2) must be slightly compressed. When closing the lid, make sure that the lid limiters (2) are not trapped between the lid and the case body.



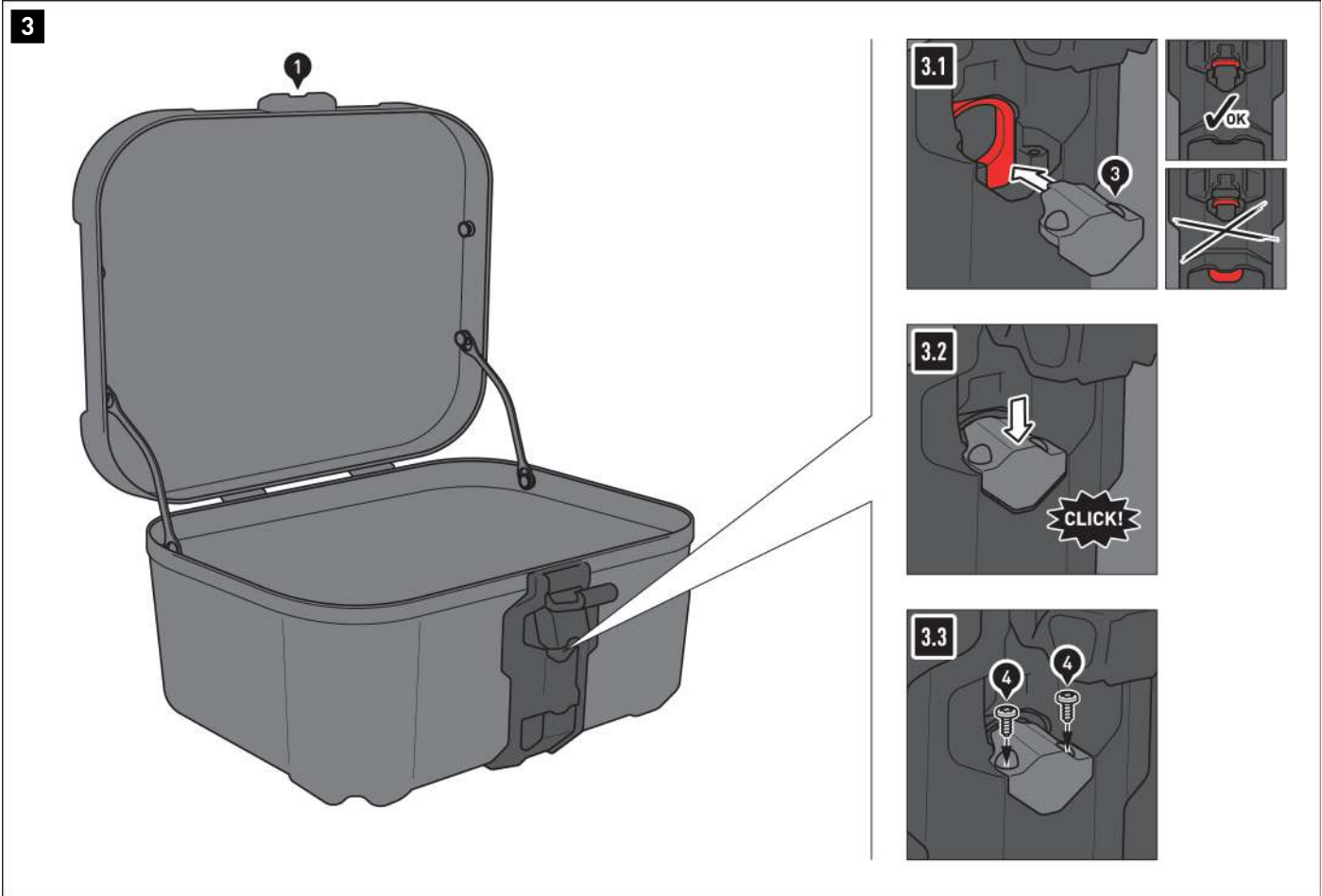

**Installing lock casing connector**

**⚠ NOTE:** If you have opted for the DUSC lock set, this step is not necessary. Install the lock set instead.

**3.1 -** Open the DUSC latch buckle (1) and position the latch housing connector (3) as shown.

**⚠ NOTE:** Make sure the locking tab is in the unlocked (up) position. If necessary, the locking tab must be pushed up into the unlocked position.

**3.2 -** Push the latch housing connector (3) down until it clicks into place.

**3.3 -** Screw in the latch housing connector (3) using the screws (4) and the torx key (5). Carefully tighten the screws by hand.

**⚠ WARNING:** Over-tightening the screws may damage the lock casing!

**⚠ NOTE:** Ensure that the locking mechanism is in working order!





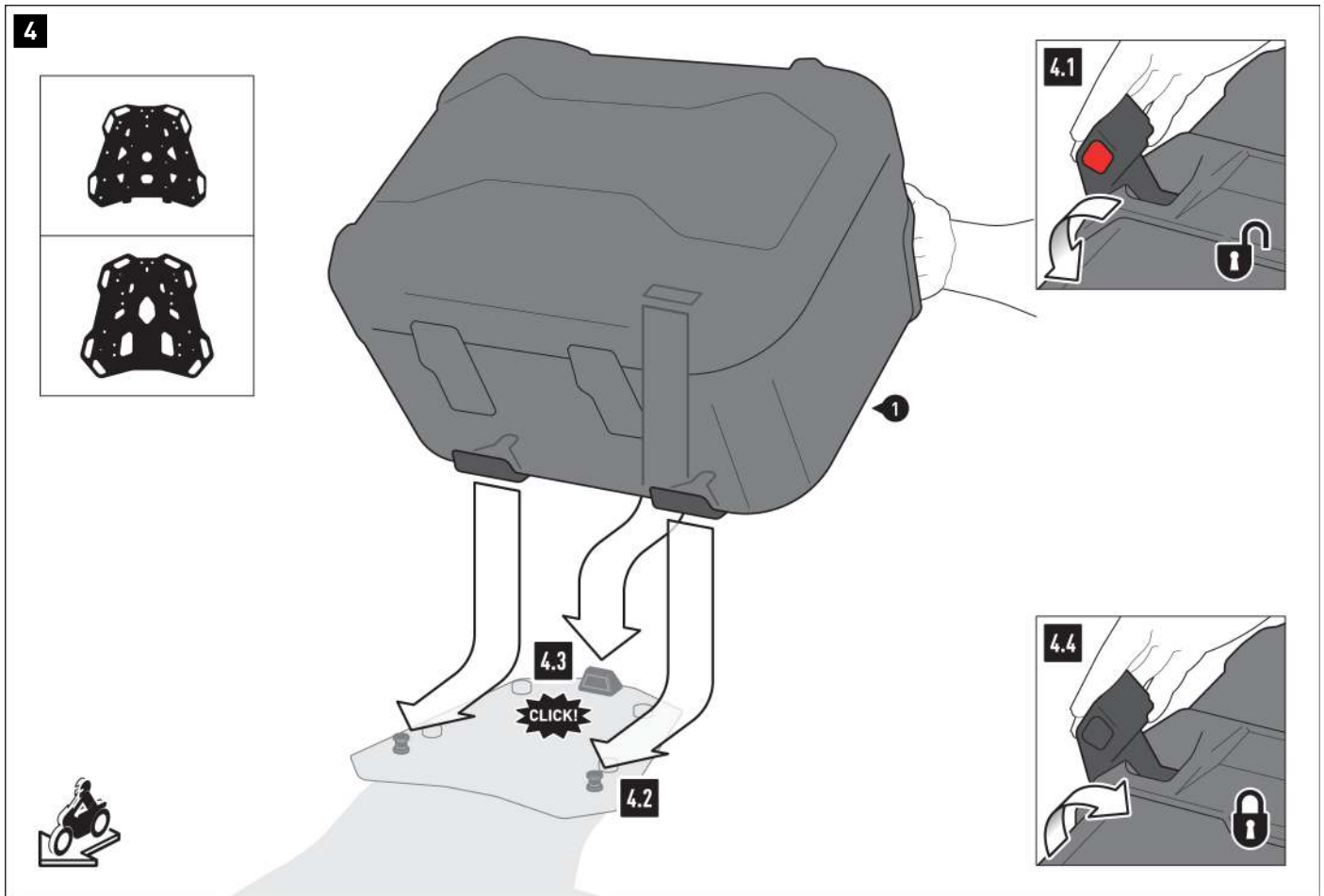

**Attaching the DUSC to a top case**

**4.1** - Press the DUSC release button (1) and pull the fastening system latch buckle to the open position.

**4.2** - Press the DUSC (1) with the two locking openings onto the mushroom-shaped supports of your SW-MOTECH rack.

**4.3** - Press the DUSC (1) with the locking opening onto the locking lug of your SW-MOTECH rack.

**▲ WARNING: You should be able to hear a clicking sound!**

**4.4** - Press the system latch buckle to closed position.

**▲ WARNING: Ensure the DUSC is firmly positioned!**

**▲ WARNING: Make sure that no components of the DUSC (1) can come into contact with any hot and moving parts on the vehicle!**

**Also ensure that all components are at least 5 cm away from hot parts as well as hot gas coming from the exhaust!**

**After assembly, make sure that this distance is maintained in all vehicle positions!**

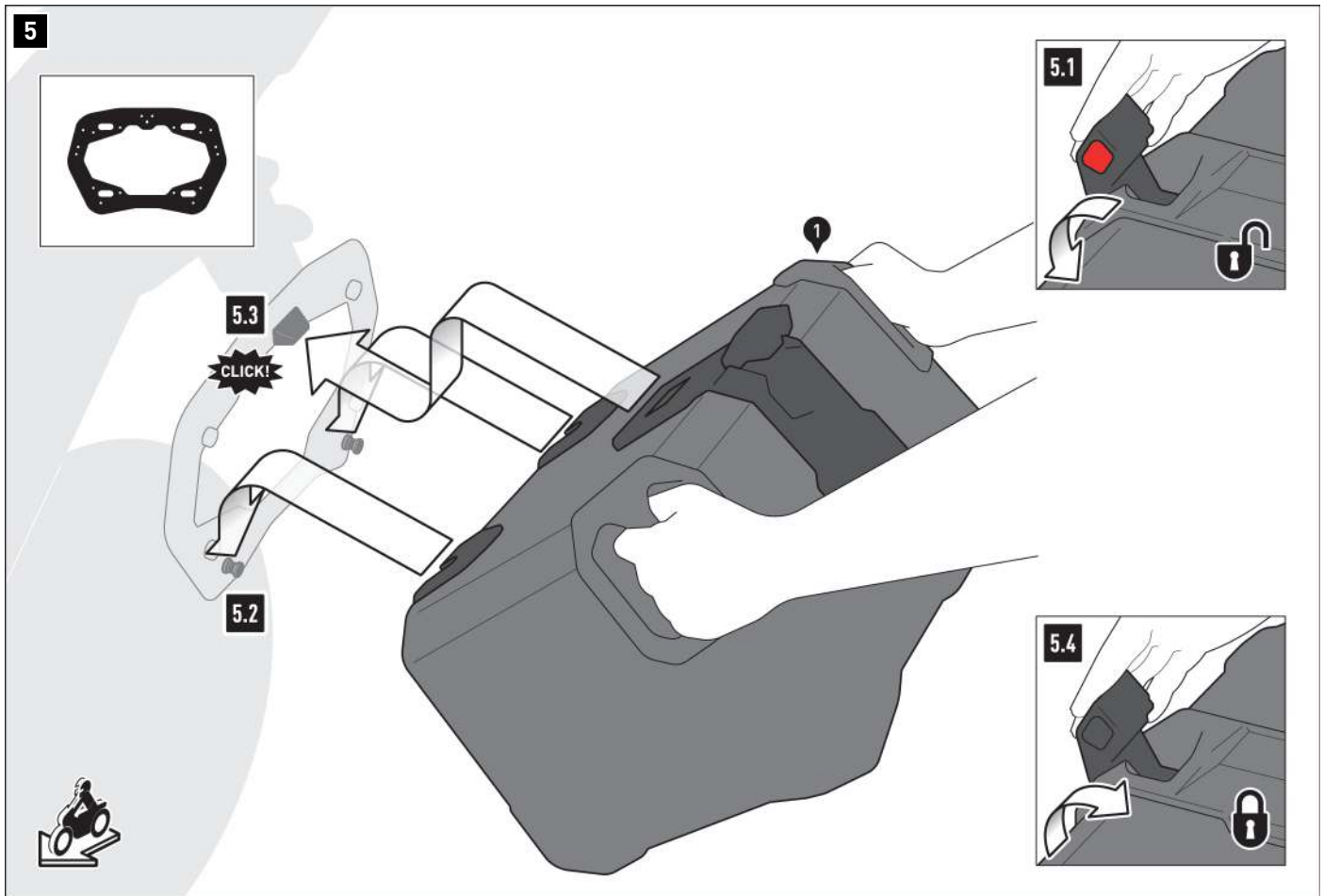

**Attaching the DUSC to a side case**

**5.1** - Press the DUSC release button (1) and pull the system latch buckle to the open position.

**5.2** - Press the DUSC (1) with the two locking openings onto the mushroom-shaped supports of your SW-MOTECH side carrier.

**5.3** - Press the DUSC (1) with the locking opening onto the locking lug of your SW-MOTECH side carrier.

**▲ WARNING: You should be able to hear a clicking sound!**

**5.4** - Press the system latch buckle to closed position.

**▲ WARNING: Ensure the DUSC is firmly positioned!**

**▲ WARNING: Make sure that no components of the DUSC (1) can come into contact with any hot and moving parts on the vehicle!**

**Also ensure that all components are at least 5 cm away from hot parts as well as hot gas coming from the exhaust!**

**After assembly, make sure that this distance is maintained in all vehicle positions!**

6

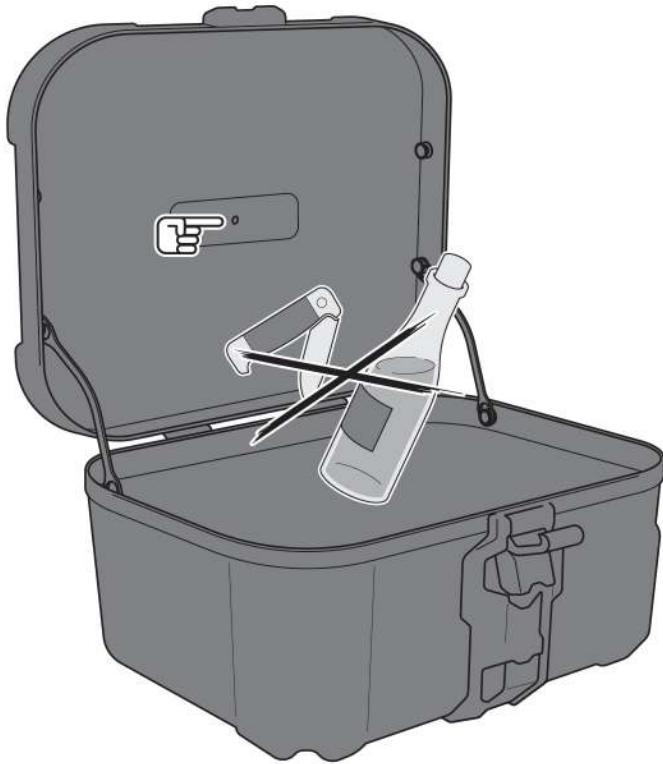

**Loading**

**⚠ WARNING: Ensure that the load is evenly distributed! Ensure that the load will not slip while driving!**

**⚠ NOTE: Make sure never to store sharp-edged, pointed or similar objects that could cause personal injury or damage to the vehicle/DUSC! Be particularly careful not to damage the overpressure membrane built into the lid!**

**Care**

Use ONLY a soft textile brush, cloth or sponge and warm soapy water for cleaning! Then rinse with clean water.

Do NOT use any harsh cleaning agents, utensils or pressure washer! Be sure to clean the DUSC after winter driving to avoid salt damage.

**⚠ NOTE: Surface materials may be subject to fluctuations in color (fading) in the event of prolonged and intensive exposure to sunlight and the elements (e.g. smog, acid rain, etc.)! SW-MOTECH is not responsible for this type of wear!**

**PRODUCT-SPECIFIC NOTES**

**⚠ NOTE:** Observe the country-specific regulations for registering/operating your vehicle or the applicable TÜV regulations. After assembly, have parts that are subject to registration entered in the vehicle documents by your test centre.

**⚠ DANGER:** Carry out a comprehensive function check before driving!

**⚠ DANGER:** Check that the product is properly positioned before departure and at every rest stop (every 200 km)!

**⚠ DANGER:** The driving/braking behavior of the motorcycle changes noticeably after the attachment of this product!

**⚠ DANGER:** Lean angle and ground clearance may be restricted by this product!

**⚠ DANGER:** The maximum vehicle load specified by the vehicle manufacturer is applicable!



≤ 10KG (≤ 22 lbs)



≤ 130km/h (≤ 80mph)

Número de artículo: HSK.00.745.11000/B

Revisión: 02 · Fecha: 08 - 2023

## DUSC L

🕒 ~ 0.25 h.

FÁCIL     COMPLICADO

**ESPAÑOL** · Gracias por elegir este producto de primera calidad de SW-MOTECH. Visite nuestra tienda online para obtener más información (p. ej., sobre el uso de los modelos). Desde esa página podrá descargar los documentos que necesite (por ejemplo, la homologación nacional de tipo).

Para evitar lesiones y daños, asegúrese de leer y comprender todas las instrucciones, advertencias de seguridad y precauciones de este manual antes de montar y utilizar el producto. Guarde estas instrucciones de montaje como referencia.

Este producto ha sido desarrollado para vehículos en condiciones de fábrica. No se garantiza la compatibilidad con los accesorios originales o de otros fabricantes.

Estas instrucciones de montaje se han redactado de acuerdo con nuestros conocimientos actuales. No hay reclamaciones legales de corrección. Salvo errores y omisiones. Nos reservamos el derecho a realizar cambios técnicos y de diseño. Los derechos de autor pertenecen a SW-MOTECH.

## SÍMBOLO DE ADVERTENCIA DE SEGURIDAD

⚠ Este símbolo de advertencia se utiliza en estas instrucciones de montaje para advertir de peligros mortales, lesiones u otros riesgos. Las palabras PELIGRO, ATENCIÓN o PRECAUCIÓN se utilizan con este símbolo de advertencia para transmitir importantes avisos de seguridad e información relacionada con el montaje y uso de este producto. Estas palabras, junto con el símbolo de advertencia de seguridad, significan:

⚠ **PELIGRO:** Indica una situación de peligro que, si no se evita, provoca lesiones graves o incluso la muerte.

⚠ **ATENCIÓN:** Indica una situación de peligro que, si no se evita, puede provocar lesiones graves o incluso la muerte.

⚠ **PRECAUCIÓN:** Indica una situación de peligro que, si no se evita, puede provocar lesiones leves o de gravedad media.

⚠ **NOTA:** Información importante, pero que no está relacionada con un riesgo de lesiones o muerte (solo daños materiales).

## INDICACIONES GENERALES

⚠ **ATENCIÓN:** El montaje y/o mantenimiento de este producto requiere conocimientos técnicos avanzados, las herramientas apropiadas, un buen manejo de dichas herramientas y conocer las especificaciones de los pares de apriete. Por su propia seguridad, SW-MOTECH recomienda que el montaje y/o el mantenimiento los realice un taller de motocicletas cualificado y certificado.

⚠ **ATENCIÓN:** Si elige ensamblar este producto usted mismo, antes de montarlo y usarlo, lea las instrucciones de montaje detenidamente y en su totalidad, y siga todas las indicaciones para evitar lesiones graves o mortales. Cuando monte y utilice el producto, tenga también en cuenta toda la información relevante que figure en el manual del vehículo. SI NO ENTIENDE ALGUNA PARTE DE ESTAS INSTRUCCIONES DE MONTAJE O NECESITA ALGUNA ACLARACIÓN, NO INTENTE INSTALAR ESTE PRODUCTO SIN CONSULTAR A SW-MOTECH PARA OBTENER AYUDA.

**PREPARACIÓN:** Lea atentamente las instrucciones de montaje y asegúrese de que todas las piezas de la lista de piezas están presentes.

⚠ **PRECAUCIÓN:** Asegúrese de que su vehículo esté estacionado de manera segura. Apague el motor y retire la llave de encendido. Deje que el motor o el escape se enfrien si es necesario. Desconecte la batería cuando trabaje en el sistema eléctrico. Utilice únicamente las herramientas adecuadas y use siempre gafas de seguridad y guantes al realizar el montaje y las tareas de mantenimiento. Pida a otra persona que le ayude con el montaje y el mantenimiento.

**MONTAJE:** Todas las piezas y conexiones retiradas del vehículo deben ser reinstaladas de acuerdo con las especificaciones del fabricante del vehículo o sustituidas por piezas y herrajes suministrados por SW-MOTECH.

⚠ **ATENCIÓN:** Asegure todas las roscas con fijador de roscas líquido de resistencia media, a menos que se especifique lo contrario.

⚠ **PELIGRO:** Los pares de apriete no definidos por SW-MOTECH deben obtenerse del fabricante del vehículo o de un taller de motocicletas certificado.

**COMPROBACIÓN FUNCIONAL:** Después del montaje, asegúrese de que no haya piezas móviles bloqueadas y de que no se altere el funcionamiento del vehículo. Los cables y tubos no deben rozarse ni quedar pinzados.

⚠ **ATENCIÓN:** Realice una comprobación exhaustiva del funcionamiento antes de iniciar la marcha. Tras los primeros 50 km y, después, con regularidad, compruebe el par de apriete de todas las conexiones y que el producto está firmemente sujeto. Los accesorios instalados pueden cambiar el comportamiento de conducción y la estabilidad del vehículo.



SW-MOTECH GmbH & Co. KG  
Ernteweg 7-10  
35282 Rauschenberg  
Alemania



✉ info@sw-motech.com  
🌐 www.sw-motech.com



Preste atención a los símbolos que figuran en la sección de MONTAJE y su significado. Cuando, en la sección de MONTAJE, aparecen las siglas OEM, se deberán seguir y aplicar las especificaciones del fabricante del vehículo.



Si tiene alguna pregunta, nuestro servicio de atención al cliente y nuestros distribuidores estarán encantados de prestarle ayuda. Encontrará nuestro número de teléfono y una lista de nuestros distribuidores en nuestra tienda online:

[www.sw-motech.com](http://www.sw-motech.com)



**No usar fijador de roscas:** Indica que no es necesario usar fijador de roscas líquido en este punto.



**Apretar a mano:** Indica que el componente se debe apretar cuidadosamente a mano.

LISTA DE PIEZAS - LEE Y CONSERVA LAS INSTRUCCIONES DE MONTAJE!

1

1



HSK.00.745.80000/B

 1/1

2

2



HSK.00.745.027.02

 2/2

3

3



HSK.00.745.047.02

 1/1

4



4 x 10; WN 1452  
SC.ST.040.010.48.1452.109

 2/2

5



T20  
TRX.T20

 1/1

1

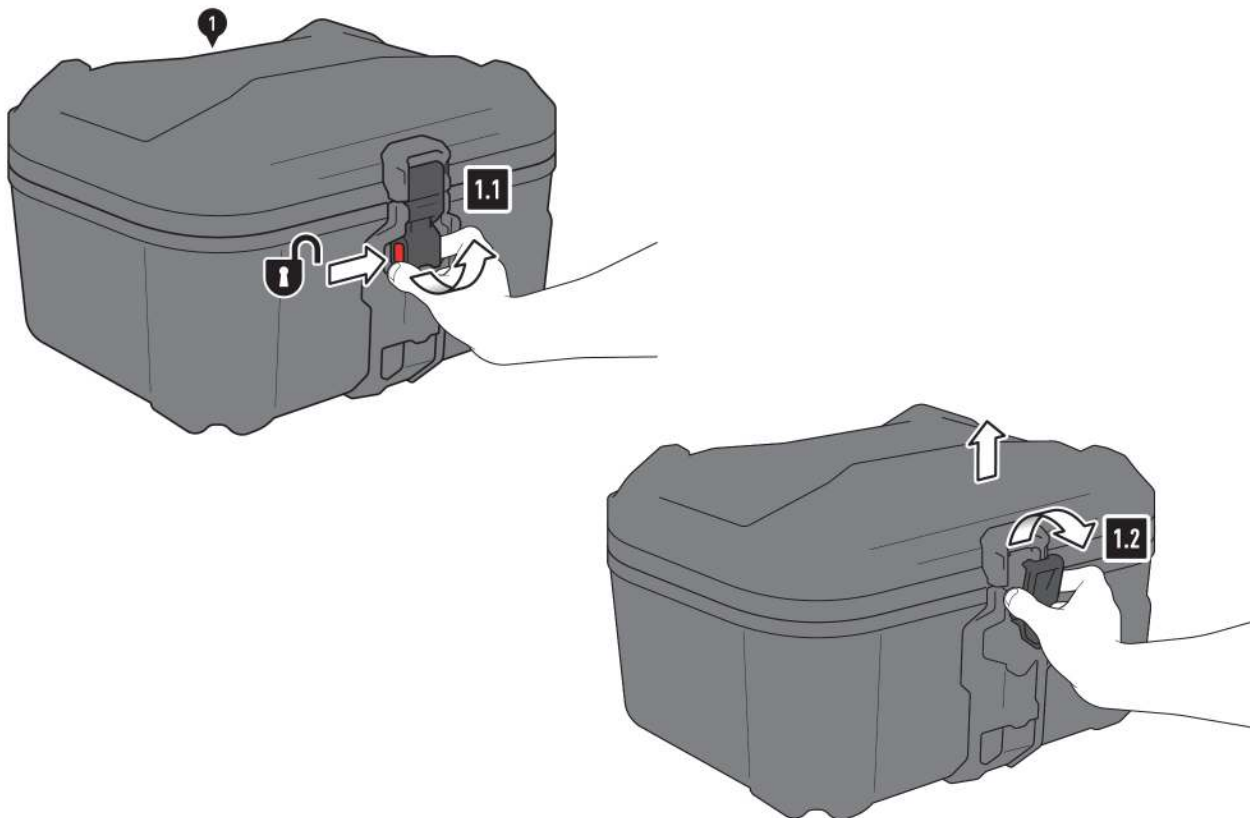

⚠ **ATENCIÓN:** ¡Use siempre protección de ojos y manos!  
⚠ **ATENCIÓN:** ¡Utilice siempre herramientas adecuadas!

#### Apertura de la tapa

1.1. Presione el botón de liberación del DUSC (1) y tire del obturador de tensión de la tapa para abrirlo.

1.2. Retire el obturador de tensión del enganche y abra la tapa.

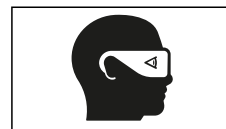



2

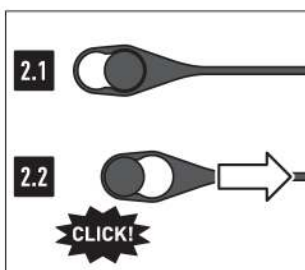
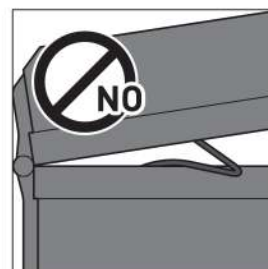
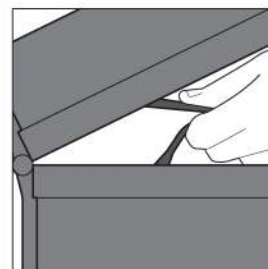
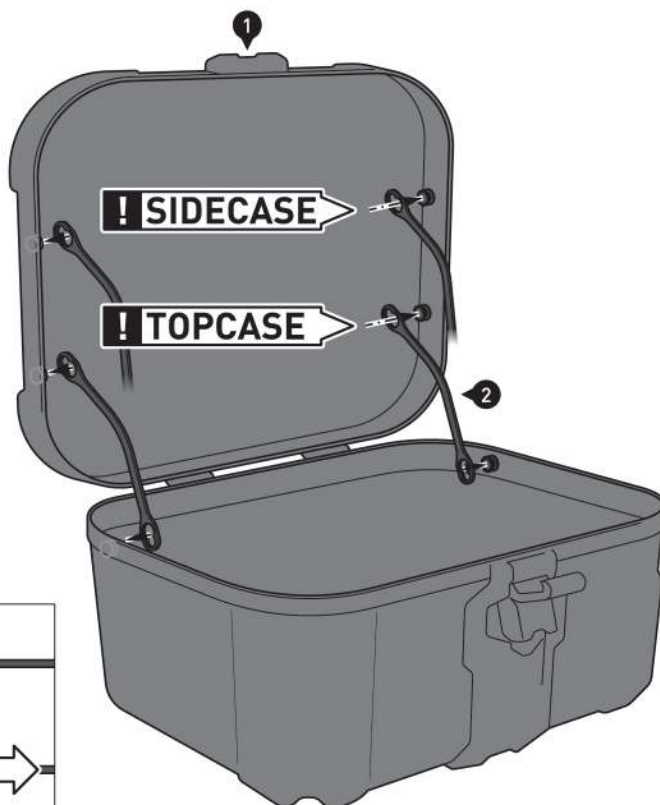

#### Instalación de los limitadores de tapa

2.1. Coloque los limitadores de tapa (2) insertando los orificios grandes en los enganches de sujeción correspondientes.

**⚠ NOTA:** Tenga en cuenta que el DUSC (1) está pensado para utilizarse como **topcase** o como **maletas laterales**. Fije los limitadores de tapa (2) a los enganches de sujeción correspondientes del DUSC (1).

2.2. Tire de los limitadores de tapa (2) para que queden fijados en su sitio.

**⚠ NOTA:** Antes de cerrar la tapa por primera vez, los limitadores de tapa (2) deben comprimirse ligeramente. Al cerrar la tapa, asegúrese de que los limitadores (2) no queden atrapados entre la tapa y el cuerpo.

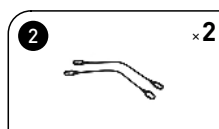



**Instalación del conector de cierre de la caja**

**⚠ NOTA:** Si ha escogido el juego de bombín para el DUSC, este paso de montaje no es necesario. No obstante, deberá instalar el juego de bombín.

**3.1.** Abra el obturador de tensión del DUSC (1) y coloque el conector de cierre de la caja (3) como se muestra en la imagen.

**⚠ NOTA:** ¡Asegúrese de que la lengüeta de bloqueo esté desbloqueada (hacia arriba)! Si es necesario, la lengüeta de bloqueo debe empujarse hacia arriba para colocarla en la posición de desbloqueo.

**3.2.** Empuje el conector de cierre de la caja (3) hacia abajo hasta que encaje en su sitio.

**3.3.** Atornille el conector de cierre de la caja (3) con los tornillos (4) y la llave torx (5). Apriete los tornillos a mano con cuidado.

**⚠ ATENCIÓN:** ¡Apretar demasiado los tornillos puede dañar la caja de la cerradura!

**⚠ NOTA:** Compruebe el funcionamiento del mecanismo de bloqueo.





#### Instalación del DUSC como topcase

**4.1.** Presione el botón de liberación del DUSC (1) y tire del obturador de tensión del sistema de cierre para abrirlo.

**4.2.** Presione el DUSC (1) colocando los dos orificios de bloqueo sobre los enganches de sujeción del portaequipaje de SW-MOTECH.

**4.3.** Presione el DUSC (1) con el orificio de cierre sobre la boca de bloqueo del portaequipaje de SW-MOTECH.

**▲ ATENCIÓN:** Deberá escuchar un chasquido para asegurarse de que la instalación es correcta.

**4.4.** Presione el obturador de tensión del sistema de cierre para colocarlo en posición cerrada.

**▲ ATENCIÓN:** Asegúrese de que el DUSC quede bien sujeto.

**▲ ATENCIÓN:** Asegúrese de que ninguna pieza del DUSC (1) pueda entrar en contacto con las piezas calientes y móviles del vehículo.

Asegúrese también de que todas las piezas estén a una distancia mínima de 5 cm de las piezas calientes y de la corriente de gas caliente procedente del tubo de escape.

Después del montaje, compruebe que esta distancia se mantenga independientemente de cómo esté el resorte del vehículo.



#### Instalación del DUSC como maleta lateral

**5.1.** Presione el botón de liberación del DUSC (1) y tire del obturador de tensión del sistema de cierre para abrirlo.

**5.2.** Presione el DUSC (1) colocando los dos orificios de bloqueo sobre los enganches de sujeción del soporte lateral de SW-MOTECH.

**5.3.** Presione el DUSC (1) con el orificio de cierre sobre la boca de bloqueo del soporte lateral de SW-MOTECH.

**▲ ATENCIÓN:** Deberá escuchar un chasquido para asegurarse de que la instalación es correcta.

**5.4.** Presione el obturador de tensión del sistema de cierre para colocarlo en posición cerrada.

**▲ ATENCIÓN:** Asegúrese de que el DUSC quede bien sujeto.

**▲ ATENCIÓN:** Asegúrese de que ninguna pieza del DUSC (1) pueda entrar en contacto con las piezas calientes y móviles del vehículo.

Asegúrese también de que todas las piezas estén a una distancia mínima de 5 cm de las piezas calientes y de la corriente de gas caliente procedente del tubo de escape.

Después del montaje, compruebe que esta distancia se mantenga independientemente de cómo esté el resorte del vehículo.

6

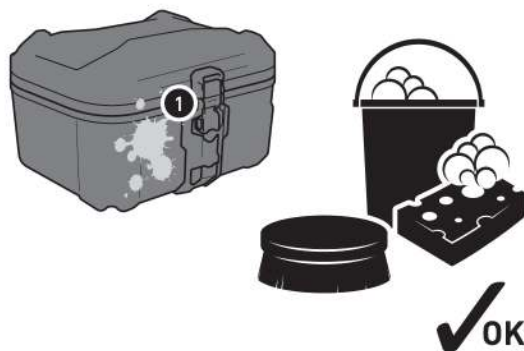

### Carga

**⚠ ATENCIÓN:** Asegúrese de distribuir la carga de manera uniforme y de que esta esté bien sujeta para que no resbale durante la conducción.

**⚠ NOTA:** Nunca guarde objetos afilados, puntiagudos o similares que puedan causar lesiones personales o daños al vehículo o al DUSC. Tenga especial cuidado de no dañar la membrana de sobrepresión integrada en la tapa.

### Cuidado

Use ÚNICAMENTE un cepillo suave para tela, un paño o una esponja y agua jabonosa tibia para limpiar el DUSC. A continuación, enjuague con agua limpia.

NO deben usarse detergentes agresivos, útiles de limpieza ásperos ni limpiadores de presión. Asegúrese de limpiar el DUSC después de conducir en invierno para evitar que se produzcan daños por la sal.

**⚠ NOTA:** Los materiales de la superficie pueden sufrir cambios de color (decoloración) en caso de una exposición prolongada e intensa a la luz solar y a las influencias ambientales (p. ej., smog, lluvia ácida, etc.). SW-MOTECH no asume ninguna responsabilidad por ello.

**INDICACIONES ESPECÍFICAS DEL PRODUCTO**

**⚠ NOTA:** *Deben respetarse las normas nacionales para la matriculación/uso del vehículo y las normas de inspección técnica vigentes. En caso de piezas con registro obligatorio, su organismo de inspección debe registrarlas en los documentos del vehículo tras el montaje.*

**⚠ PELIGRO:** ¡Efectúe una comprobación exhaustiva del funcionamiento antes de iniciar la conducción!

**⚠ PELIGRO:** ¡Compruebe que el producto esté colocado correctamente antes de iniciar la marcha y en cada parada de descanso (cada 200 km)!

**⚠ PELIGRO:** ¡El comportamiento de conducción/frenado de la motocicleta cambia notablemente después de fijar este producto!

**⚠ PELIGRO:** ¡Este producto puede limitar el ángulo de inclinación y la distancia al suelo!

**⚠ PELIGRO:** ¡Se aplica la carga máxima del vehículo especificada por el fabricante del vehículo!



≤ 10 kg (≤ 22 libras)



≤ 130 km/h (≤ 80 mph)

Numéro d'article: HSK.00.745.11000/B

Révision: 02 · Date: 08 - 2023

## DUSC L

 ~ 0.25 h.FACILE     DIFFICILE

**FRANÇAIS** · Nous vous remercions d'avoir choisi ce produit haut de gamme de SW-MOTECH. Visitez notre boutique en ligne pour plus d'informations (par exemple affectation des modèles). Les documents nécessaires (par exemple ABE) y sont disponibles en téléchargement.

**Veillez lire et prendre en compte toutes les instructions, les consignes de sécurité et les avertissements contenus dans ce manuel de montage avant de monter et d'utiliser le produit afin d'éviter toute blessure ou tout dommage. Veuillez conserver la notice d'utilisation pour référence.**

**Ce produit a été développé pour des véhicules en configuration d'usine. Nous ne sommes pas en mesure d'assurer la compatibilité avec les pièces de rechange originales ou les pièces de rechange d'autres fabricants.**

**La présente notice d'installation a été élaborée conformément à nos connaissances actuelles. Il n'existe aucun droit juridique à l'exactitude des informations qu'elle contient. Sous réserve d'erreurs et de fautes. Sous réserve de modifications techniques et conceptuelles. SW-MOTECH détient les droits d'auteur.**

## SYMBOLE D'AVERTISSEMENT DE SÉCURITÉ

**⚠ Ce symbole d'avertissement est utilisé dans ces instructions de montage pour mettre en garde contre des dangers mortels, de blessures ou d'autres risques. Les mots DANGER, ATTENTION ou RECOMMANDATION sont utilisés avec ce symbole d'avertissement pour transmettre des consignes de sécurité et des informations importantes concernant le montage et l'utilisation de ce produit. Ces mots, associés au symbole d'avertissement de sécurité, signifient :**

**⚠ DANGER :** signale une situation dangereuse pouvant entraîner la mort ou des blessures graves si elle n'est pas évitée !

**⚠ ATTENTION :** signale une situation dangereuse pouvant entraîner la mort ou des blessures graves si elle n'est pas évitée !

**⚠ PRUDENCE :** Indique une situation dangereuse susceptible d'entraîner des blessures de gravité réduite ou moyenne si elle se présente !

**⚠ REMARQUE :** Informations importantes, mais qui n'entraînent pas de risque de décès ou de blessure (dommages matériels uniquement).

## REMARQUES GÉNÉRALES

**⚠ ATTENTION :** le montage et/ou l'entretien de ce produit nécessite des compétences techniques avancées, des outils appropriés et une bonne compréhension de l'utilisation des outils et des indications de réglage. Pour votre propre sécurité, SW-MOTECH recommande de confier le montage et/ou l'entretien à un atelier de réparation de deux-roues qualifié et certifié.

**⚠ ATTENTION :** si vous décidez de monter vous-même ce produit, lisez attentivement et intégralement les instructions de montage avant le montage et l'utilisation et suivez toutes les instructions afin d'éviter des blessures graves ou mortelles. Lors du montage et de l'utilisation, tenez également compte de toutes les informations pertinentes du manuel du véhicule. **SI VOUS NE COMPRENEZ PAS UNE PARTIE DE CE MANUEL D'INSTALLATION OU SI VOUS AVEZ BESOIN D'EXPLICATIONS CONCERNANT UNE INSTRUCTION, N'ESSAYEZ PAS D'INSTALLER CE PRODUIT SANS DEMANDER DE L'AIDE À SW-MOTECH !**

**PRÉPARATION :** Veuillez lire attentivement les instructions de montage et assurez-vous que tous les éléments de la liste de pièces sont présents.

**⚠ PRUDENCE :** veillez à ce que votre véhicule soit bien stable. Éteignez le moteur et retirez la clé de contact. Laissez refroidir le moteur/l'échappement si nécessaire. Débranchez la batterie lorsque vous travaillez sur le système électrique. Utilisez uniquement des outils appropriés et portez toujours des lunettes de protection et des gants pendant le montage et l'entretien. Faites-vous aider par une deuxième personne lors du montage et de l'entretien.

**MONTAGE :** Toutes les pièces et connexions retirées du véhicule doivent être réinstallées conformément aux instructions du fabricant du véhicule ou remplacées par des pièces et du matériel fournis par SW-MOTECH.

**⚠ ATTENTION** Sauf indication contraire, sécurisez tous les filetages avec du frein filet liquide de force moyenne.

**⚠ DANGER :** Les couples de serrage non définis par SW-MOTECH doivent être obtenus auprès du constructeur du véhicule ou d'un atelier de réparation de motos certifié.

**CONTRÔLE DU FONCTIONNEMENT :** Après le montage, assurez-vous qu'aucune pièce mobile n'est bloquée et que le fonctionnement du véhicule n'est pas perturbé. Les câbles et les tuyaux ne doivent pas frotter et/ou être coincés.

**⚠ ATTENTION :** Effectuez un contrôle de fonctionnement complet avant de commencer à rouler. Après les 50 premiers kilomètres, puis régulièrement, vérifiez le couple de serrage de tous les raccords et la bonne fixation du produit. Les accessoires montés peuvent modifier le comportement sur la route et la stabilité du véhicule.



SW-MOTECH GmbH & Co. KG  
Ernteweg 7-10  
35282 Rauschenberg  
Allemagne



[info@sw-motech.com](mailto:info@sw-motech.com)  
[www.sw-motech.com](http://www.sw-motech.com)



Vous trouverez les symboles et leur signification dans la section MONTAGE. Si le terme OEM apparaît dans la section MONTAGE, il faut respecter et appliquer les consignes du fabricant du véhicule.



Si vous avez des questions, notre service clientèle ainsi que nos distributeurs se tiennent à votre disposition. Vous trouverez notre numéro de téléphone ainsi que la liste de nos distributeurs sur notre boutique en ligne : [www.sw-motech.com](http://www.sw-motech.com)



**Ne pas utiliser de frein filet** : signifie que l'utilisation d'un frein filet liquide n'est pas nécessaire à ce stade.



**Serrer manuellement** : indique que la pièce de montage doit être serrée à la main avec précaution.



LISTE DES PIÈCES - LIRE ET CONSERVER LES INSTRUCTIONS DE MONTAGE!

1

1



HSK.00.745.80000/B

 1/1

2

2



HSK.00.745.027.02

 2/2

3

3



HSK.00.745.047.02

 1/1

4



4 x 10; WN 1452  
SC.ST.040.010.48.1452.109

 2/2

5



T20  
TRX.T20

 1/1

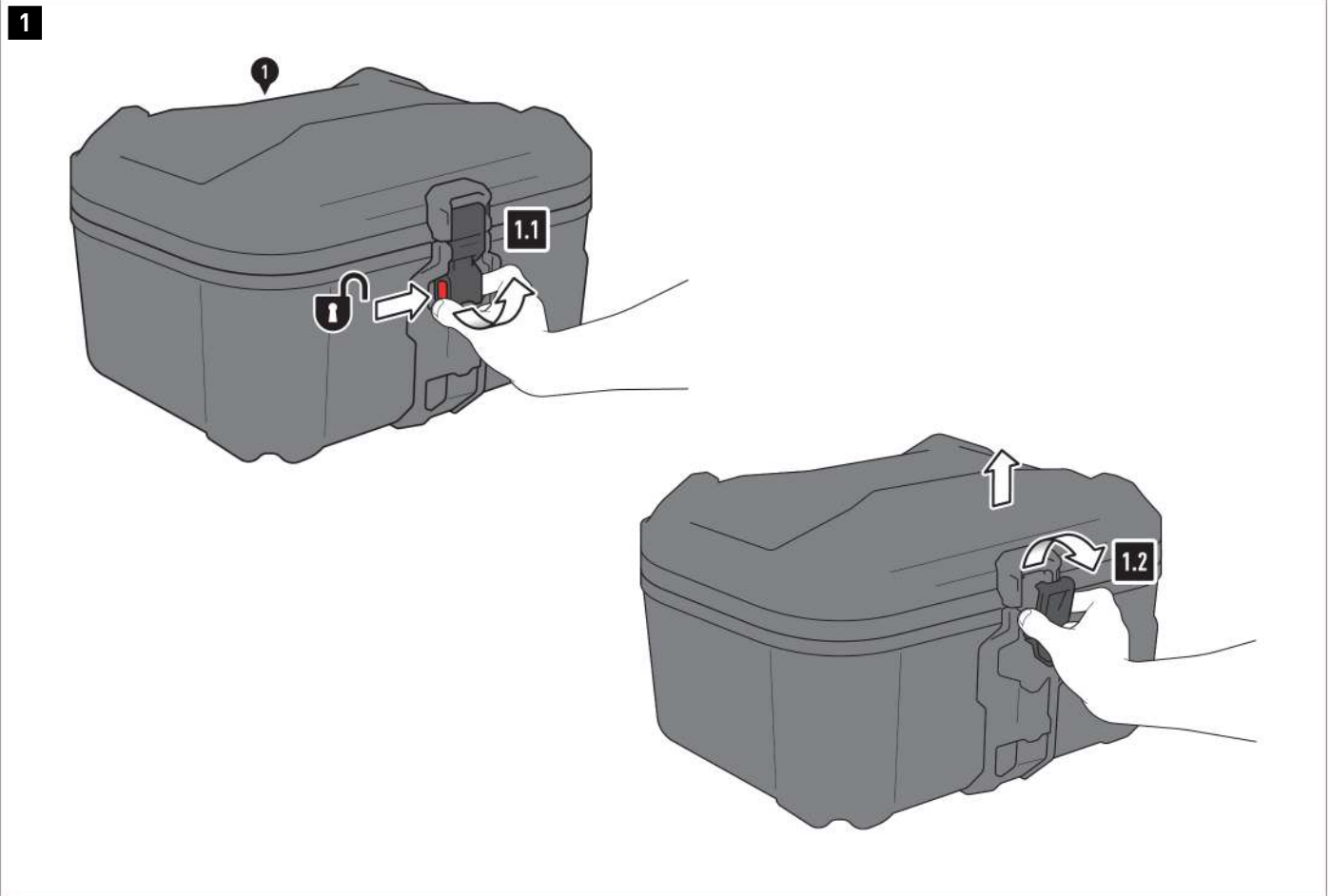

**⚠ ATTENTION : portez toujours des lunettes et des gants de protection !**  
**⚠ ATTENTION : Utilisez toujours des outils appropriés !**

#### Ouverture du couvercle

1.1 - Appuyez sur le bouton de déverrouillage de la valise DUSC (1) et tirez le verrou du couvercle en position ouverte.

1.2 - Retirez le verrou du support de verrou et ouvrez le couvercle.

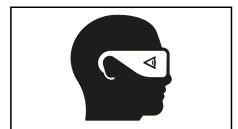

2

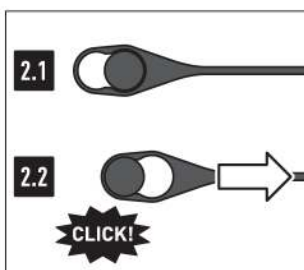
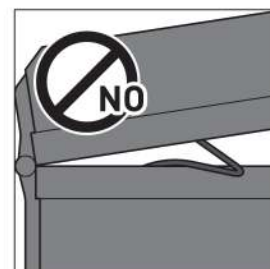
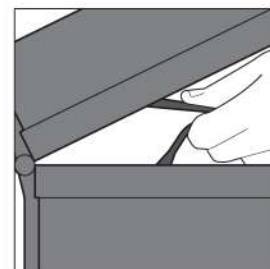
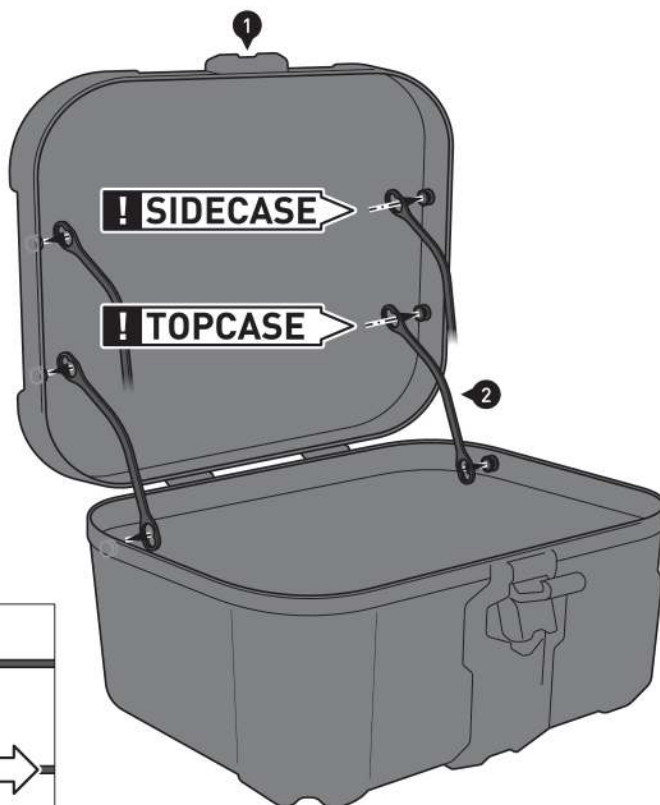

**Installation des limiteurs d'ouverture du couvercle**

**2.1** - Insérez les limiteurs d'ouverture de couvercle (2) avec les grandes ouvertures sur les cales de maintien prévues à cet effet.  
**⚠ REMARQUE** : respectez l'utilisation prévue du DUSC (1) : **topcase** ou **valise latérale**. Fixez les limiteurs d'ouverture de couvercle (2) sur les cales de maintien respectives du DUSC (1).

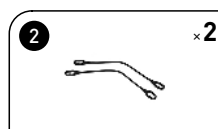

**2.2** - Tirez les limiteurs d'ouverture de couvercle (2) en position de fixation.

**⚠ REMARQUE** : Avant la première fermeture du couvercle, les limiteurs de couvercle (2) doivent être légèrement comprimés. Lors de la fermeture du couvercle, assurez-vous que les limiteurs de couvercle (2) ne soient pas coincés entre le couvercle et le boîtier.

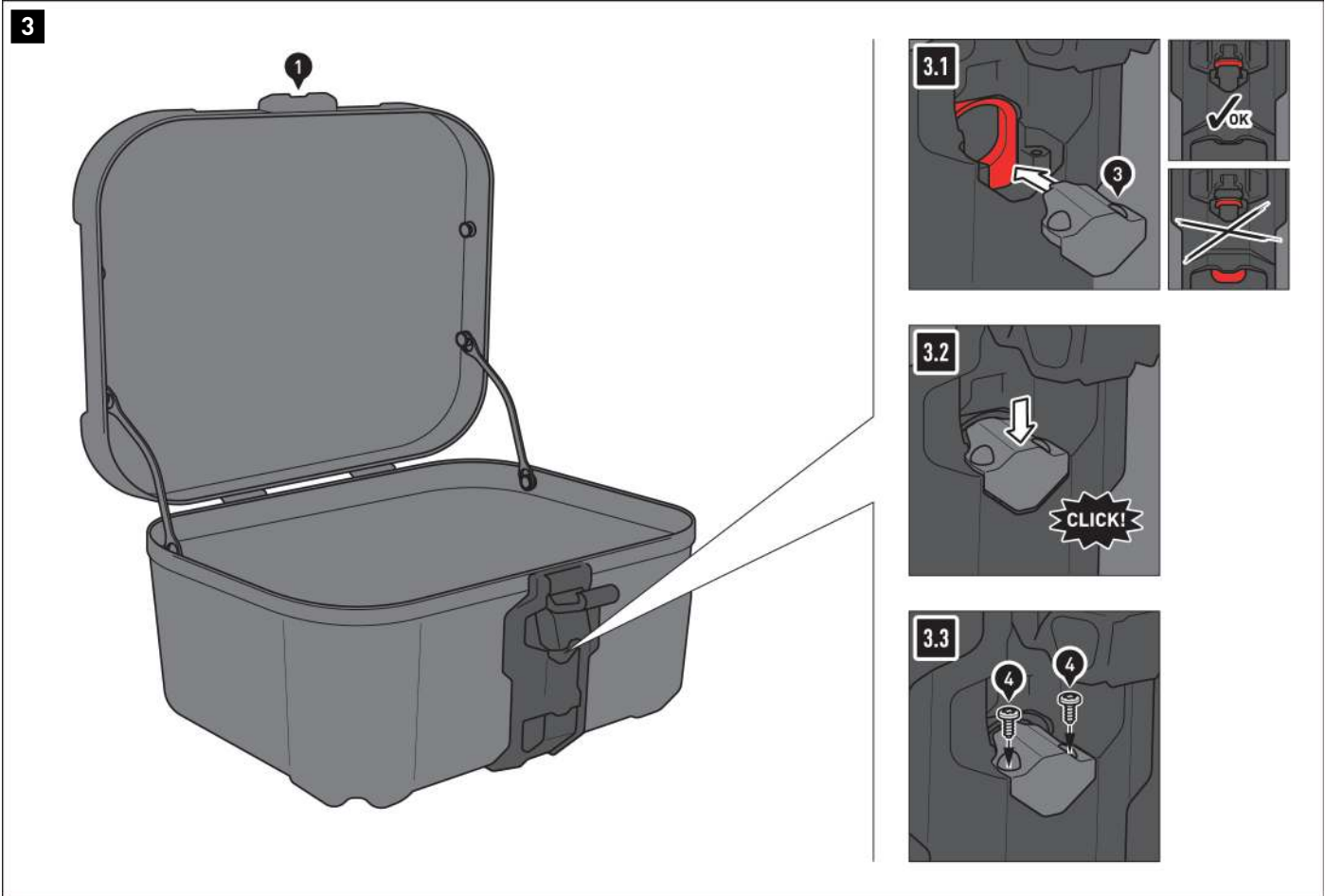

**Installer le bloc de fermeture**

⚠ **REMARQUE :** Si vous avez opté pour le kit de serrures pour DUSC, cette étape de montage n'est pas nécessaire. Installez le kit de serrures à la place.

**3.1** - Ouvrez le verrou du DUSC (1) et positionnez le bloc de fermeture (3) comme indiqué.

⚠ **REMARQUE :** Assurez-vous que la languette de verrouillage est en position déverrouillée (vers le haut) ! Si nécessaire, la languette de verrouillage doit être poussée vers le haut en position déverrouillée !

**3.2** - Poussez le bloc de fermeture (3) vers le bas jusqu'à ce qu'il s'enclenche.

**3.3** - Vissez le bloc de fermeture (3) avec les vis (4) et la clé Torx (5). Serrez les vis avec précaution et à la main.

⚠ **ATTENTION :** un serrage excessif des vis peut endommager le boîtier de la serrure !

⚠ **REMARQUE :** vérifiez le fonctionnement du mécanisme de verrouillage !





#### Installation du DUSC en topcase

**4.1** - Appuyez sur le bouton de déverrouillage du DUSC (1) et tirez le verrou du système de verrouillage en position ouverte.

**4.2** - Appuyez le DUSC (1) avec les deux ouvertures d'arrêt sur les cales de maintien de votre porte-bagages SW-MOTECH.

**4.3** - Appuyez le DUSC (1) avec l'ouverture de verrouillage sur le bouton de verrouillage de votre porte-bagages SW-MOTECH.

**▲ ATTENTION : soyez attentif au déclic d'enclenchement bien audible !**

**4.4** - Poussez le verrou du système de verrouillage en position fermée.

**▲ ATTENTION : vérifiez que le DUSC soit bien fixé !**

**▲ ATTENTION : assurez-vous qu'aucun composant du DUSC (1) ne puisse entrer en contact avec des pièces chaudes et mobiles du véhicule ! Assurez-vous également que tous les composants soient à une distance d'au moins 5 cm des pièces chaudes, ainsi que du flux d'échappement chaud du pot d'échappement !**

**Après le montage, assurez-vous que cette distance soit respectée, quel que soit l'état de charge du véhicule !**



#### Installation du DUSC en valise latérale

**5.1** - Appuyez sur le bouton de déverrouillage du DUSC (1) et tirez le verrou du système de verrouillage en position ouverte.

**5.2** - Appuyez le DUSC (1) avec les deux ouvertures d'arrêt sur les cales de maintien de votre support latéral SW-MOTECH.

**5.3** - Appuyez le DUSC (1) avec l'ouverture de verrouillage sur le bouton de verrouillage de votre support latéral SW-MOTECH.

**▲ ATTENTION : soyez attentif au déclic d'enclenchement bien audible !**

**5.4** - Poussez le verrou du système de verrouillage en position fermée.

**▲ ATTENTION : vérifiez que le DUSC soit bien fixé !**

**▲ ATTENTION : assurez-vous qu'aucun composant du DUSC (1) ne puisse entrer en contact avec des pièces chaudes et mobiles du véhicule !**

**Assurez-vous également que tous les composants soient à une distance d'au moins 5 cm des pièces chaudes, ainsi que du flux d'échappement chaud du pot d'échappement !**

**Après le montage, assurez-vous que cette distance soit respectée, quel que soit l'état de charge du véhicule !**

6

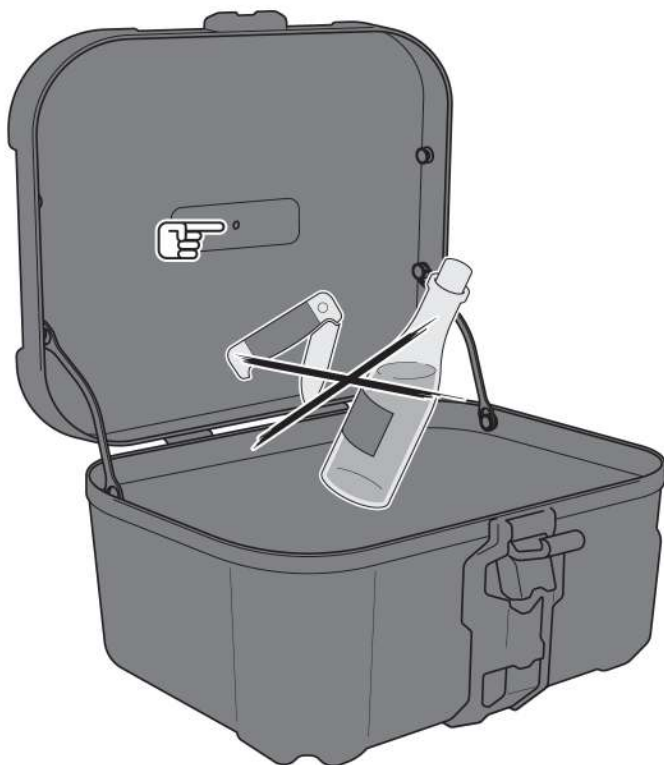

#### Charge

**▲ ATTENTION :** veillez à ce que la charge soit répartie uniformément ! Assurez-vous que le chargement soit bien fixé pour éviter qu'il ne glisse pendant le trajet !

**△ REMARQUE :** assurez-vous de ne jamais stocker d'objets tranchants, pointus ou similaires qui pourraient blesser des personnes ou endommager le véhicule/le DUSC ! Faites particulièrement attention à ne pas endommager la membrane de surpression intégrée au couvercle !

#### Entretien

Pour le nettoyage, utilisez UNIQUEMENT une brosse textile douce, un chiffon ou une éponge et de l'eau chaude savonneuse ! Rincez ensuite à l'eau claire. N'utilisez PAS de produits détergents agressifs, des ustensiles de nettoyage durs ou un nettoyeur haute pression ! Nettoyez impérativement le DUSC après les trajets en hiver pour éviter les dommages causés par le sel.

**△ REMARQUE :** Les matériaux de surface peuvent subir des changements de couleur (décoloration) en cas d'exposition prolongée et intensive au soleil et aux influences environnementales (par ex. brouillard, pluies acides, etc.) ! SW-MOTECH décline toute responsabilité à cet égard !

**REMARQUES SPÉCIFIQUES AU PRODUIT**

**⚠ REMARQUE :** Respectez les réglementations spécifiques au pays pour l'immatriculation/l'utilisation de votre véhicule ou les réglementations TÜV applicables. Après le montage, faites inscrire les pièces soumises à immatriculation dans les papiers du véhicule par votre centre de contrôle.

**⚠ DANGER :** Effectuez un contrôle de fonctionnement complet avant de prendre la route !

**⚠ DANGER :** Vérifiez le bon positionnement du produit avant de démarrer et à chaque halte (tous les 200 km) !

**⚠ DANGER :** Le comportement de conduite/freinage de la moto change sensiblement après la fixation de ce produit !

**⚠ DANGER :** La capacité d'inclinaison et la garde au sol peuvent être réduites par ce produit !

**⚠ DANGER :** La charge maximale du véhicule indiquée par le constructeur automobile s'applique !



≤ 10 KG (≤ 22 lbs)



≤ 130 km/h (≤ 80mph)



Numero di articolo: HSK.00.745.11000/B

Revisione: 02 · Data: 08 - 2023

## DUSC L

 ~ 0.25 h.FACILE     DIFFICILE

**ITALIANO** -Grazie per aver scelto questo prodotto premium di SW-MOTECH. Visita il nostro negozio online per ulteriori informazioni (ad es. per la compatibilità con i vari modelli). I documenti richiesti (ad es. certificato di omologazione nazionale) possono essere scaricati qui.

**Si prega di leggere attentamente le avvertenze di sicurezza e le istruzioni per il montaggio prima di montare e utilizzare il prodotto, al fine di evitare eventuali lesioni e danni. Conserva queste istruzioni per il montaggio come riferimento futuro.**

**Questo prodotto è stato sviluppato per veicoli in condizioni di fabbrica. La compatibilità con gli accessori originali o di altri produttori non può essere garantita.**

**Queste istruzioni per il montaggio sono state redatte in base alle nostre conoscenze attuali. Non sussistono pretese di correttezza giuridiche. Salvo errori ed omissioni. Ci riserviamo il diritto di apportare modifiche tecniche e di design. Copyright SW-MOTECH.**

## SIMBOLO DI SICUREZZA

 Questo simbolo di avvertenza è usato nelle presenti istruzioni di montaggio per segnalare pericoli mortali, rischio di lesioni o altri pericoli. Le parole "PERICOLO", "AVVERTENZA" O "ATTENZIONE" sono utilizzate con questo simbolo di avvertenza per trasmettere importanti istruzioni di sicurezza e informazioni relative al montaggio e all'uso di questo prodotto. Queste parole, utilizzate insieme al simbolo di avvertenza, significano:

**▲ PERICOLO:** indica una situazione di pericolo che, se non evitata, può causare morte o lesioni gravi!

**▲ AVVERTENZA:** indica una situazione di pericolo che, se non evitata, può causare morte o lesioni gravi!

**▲ ATTENZIONE:** indica una situazione di pericolo che, se non evitata, può provocare lesioni lievi o di entità moderata!

**▲ AVVISO:** indica informazioni importanti che non riguardano il rischio di morte o di lesioni (riguardano unicamente il rischio di danni materiali)!

## INFORMAZIONI GENERALI

**▲ AVVERTENZA:** il montaggio e/o la manutenzione di questo prodotto richiedono competenze tecniche avanzate, strumenti adeguati e una buona conoscenza dell'uso della strumentazione e delle indicazioni relative alle coppie di serraggio. Per ragioni di sicurezza, SW-MOTECH raccomanda di far eseguire il montaggio e/o la manutenzione presso un'officina per motociclette qualificata e certificata.

**▲ AVVERTENZA:** se si decide di installare questo prodotto in autonomia, leggere attentamente le istruzioni per il montaggio prima del montaggio e dell'uso e seguire tutte le avvertenze per evitare lesioni gravi o mortali. Durante il montaggio e l'uso, seguire anche tutte le istruzioni pertinenti contenute nel manuale del veicolo. **SE NON SI COMPRENDONO TALI ISTRUZIONI, ANCHE SOLO IN PARTE, O SE SONO NECESSARI CHIARIMENTI, NON CERCARE DI MONTARE IL PRODOTTO IN AUTONOMIA SENZA CHIEDERE IL SUPPORTO DI SW-MOTECH!**

**PREPARAZIONE:** leggere attentamente le istruzioni per il montaggio e assicurarsi che siano disponibili tutti i componenti contenuti nella lista.

**▲ ATTENZIONE:** assicurarsi che il veicolo sia perfettamente fermo. Spegner il motore e togliere la chiave. Se necessario, lasciar raffreddare il motore/lo scarico. Scollegare la batteria quando si interviene sull'impianto elettrico. Usare esclusivamente strumenti idonei e indossare sempre occhiali e guanti protettivi durante le operazioni di montaggio e manutenzione. Chiedere aiuto a una seconda persona durante le fasi di montaggio e manutenzione.

**MONTAGGIO:** tutti i componenti e i collegamenti rimossi dal veicolo devono essere reinstallati secondo le specifiche del produttore del veicolo o sostituiti con componenti e attrezzatura forniti da SW-MOTECH.

**▲ AVVERTENZA:** fissare tutte le filettature con frenafili liquido a media resistenza, se non diversamente specificato.

**▲ PERICOLO:** le coppie di serraggio non definite da SW-MOTECH devono essere richieste al costruttore del veicolo o a un'officina certificata.

**CONTROLLO DI FUNZIONALITÀ:** dopo il montaggio accertarsi che non vi siano parti mobili bloccate e che il funzionamento del veicolo non sia compromesso. I cavi e i tubi flessibili non devono sfregare e/o essere schiacciati.

**▲ AVVERTENZA:** eseguire un controllo completo delle funzioni prima di mettersi alla guida. Controllare la coppia di serraggio di tutti i collegamenti e la tenuta del prodotto dopo i primi 50 km e in seguito regolarmente. Gli accessori montati possono modificare la maneggevolezza e la stabilità del veicolo.



SW-MOTECH GmbH & Co. KG  
Ernteweg 7-10  
35282 Rauschenberg  
Germania



info@sw-motech.com  
www.sw-motech.com



Consultare i simboli e il loro significato nella sezione MONTAGGIO. Se nella sezione montaggio compare la sigla OEM, è necessario rispettare e applicare le specifiche del produttore del veicolo.



Per qualsiasi domanda, non esitare a contattare il nostro servizio clienti o i nostri distributori. Il nostro numero di telefono e l'elenco dei nostri distributori sono disponibili nel nostro negozio online:  
**[www.sw-motech.com](http://www.sw-motech.com)**



**Non utilizzare il frenafidetti:** segnala di non dover utilizzare il frenafidetti liquido in quel determinato punto.



**Serrare a mano:** indica che l'elemento di fissaggio deve essere serrato a mano con cautela.

**1**

**1**



HSK.00.745.80000/B

 1/1

**2**

**2**



HSK.00.745.027.02

 2/2

**3**

**3**



HSK.00.745.047.02

 1/1

**4**



4 x 10; WN 1452  
SC.ST.040.010.48.1452.109

 2/2

**5**



T20  
TRX.T20

 1/1

1

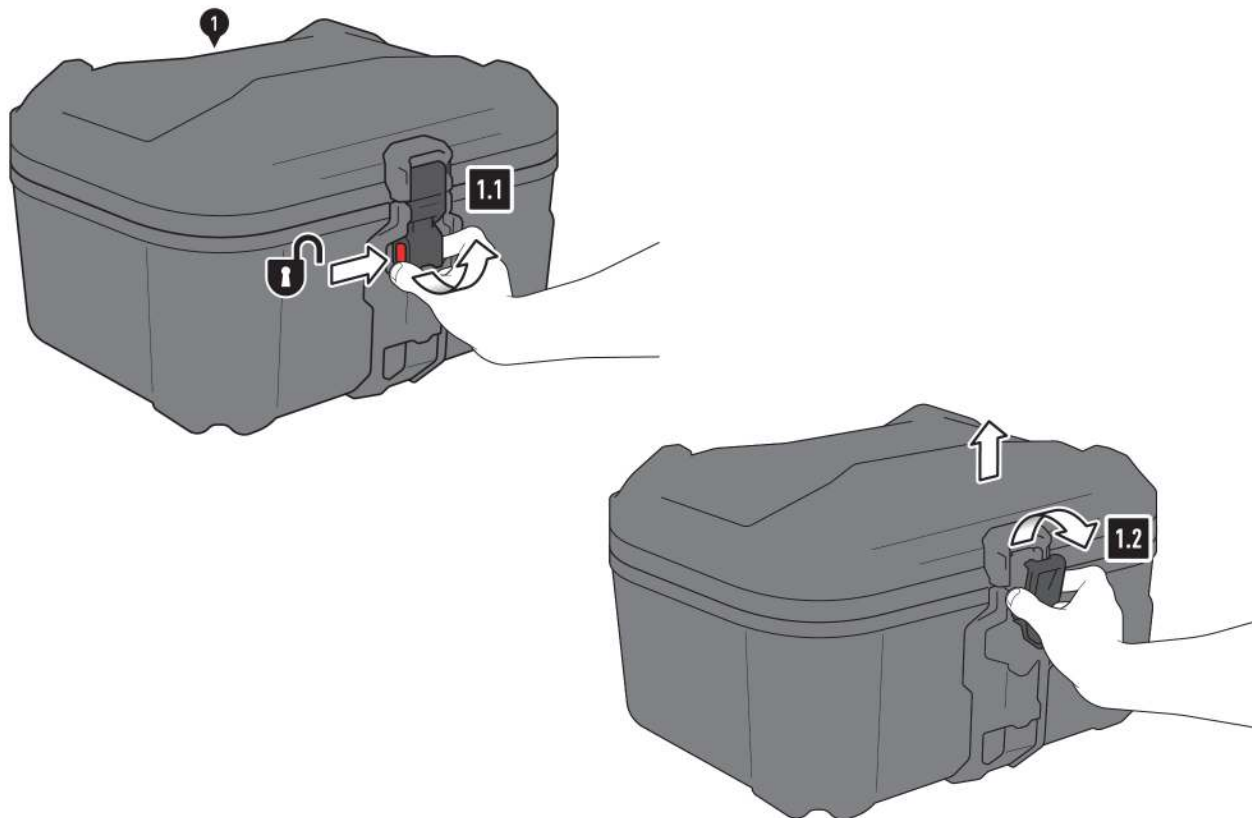

- ▲ AVVERTENZA: indossare sempre le protezioni per gli occhi e per le mani!
- ▲ AVVERTENZA: Utilizzare sempre strumenti adeguati!

**Apertura del coperchio**

1.1 - Premere il pulsante di rilascio del sistema DUSC (1) e tirare la chiusura di bloccaggio del coperchio in posizione aperta.

1.2 - Rimuovere la chiusura di bloccaggio dalla relativa staffa e aprire il coperchio.

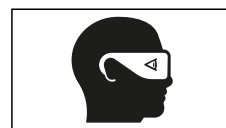

2

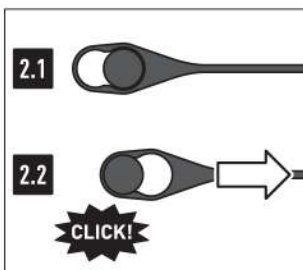
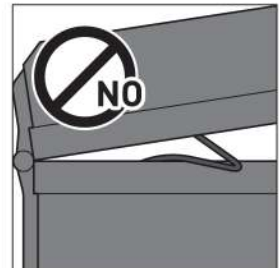
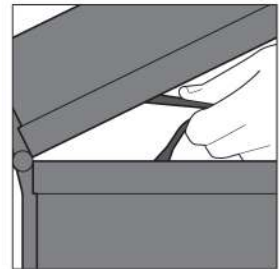
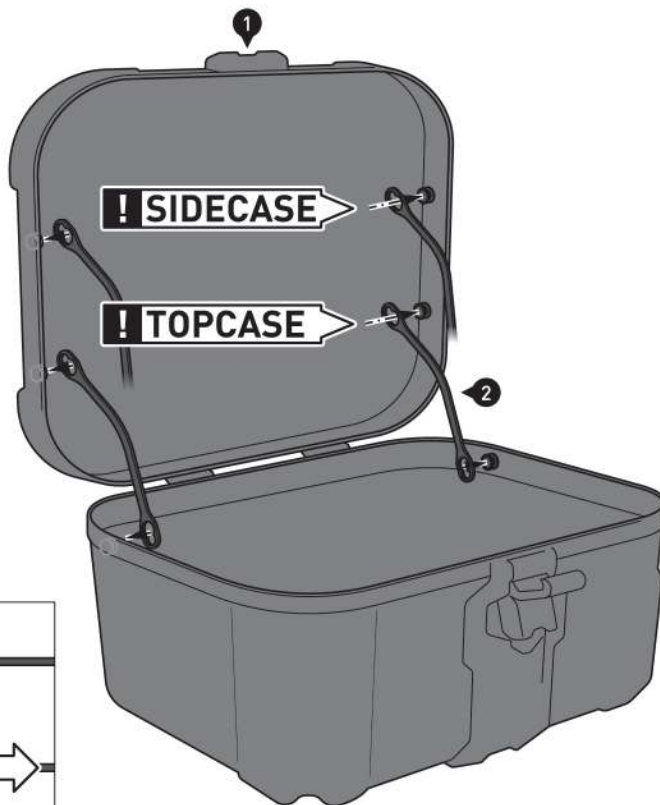

**Montaggio dei limitatori di apertura del coperchio**

**2.1** - Inserire i limitatori di apertura del coperchio (2) con le aperture grandi rivolte sugli appositi funghi di contenimento  
**⚠ AVVISO:** prestare attenzione alla destinazione d'uso degli accessori DUSC (1): **bauletto** oppure **valigia laterale**. Fissare i limitatori di apertura del coperchio (2) al rispettivo fungo di contenimento del sistema DUSC (1).

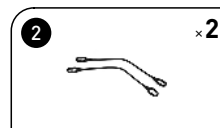

**2.2** - Tirare i limitatori di apertura del coperchio (2) in posizione di fissaggio.

**⚠ AVVISO:** prima di chiudere il coperchio per la prima volta, i relativi limitatori di apertura (2) devono essere leggermente ricalcati. Al momento della chiusura del coperchio, assicurarsi che i limitatori di apertura del coperchio (2) non siano bloccati tra il coperchio e il corpo.

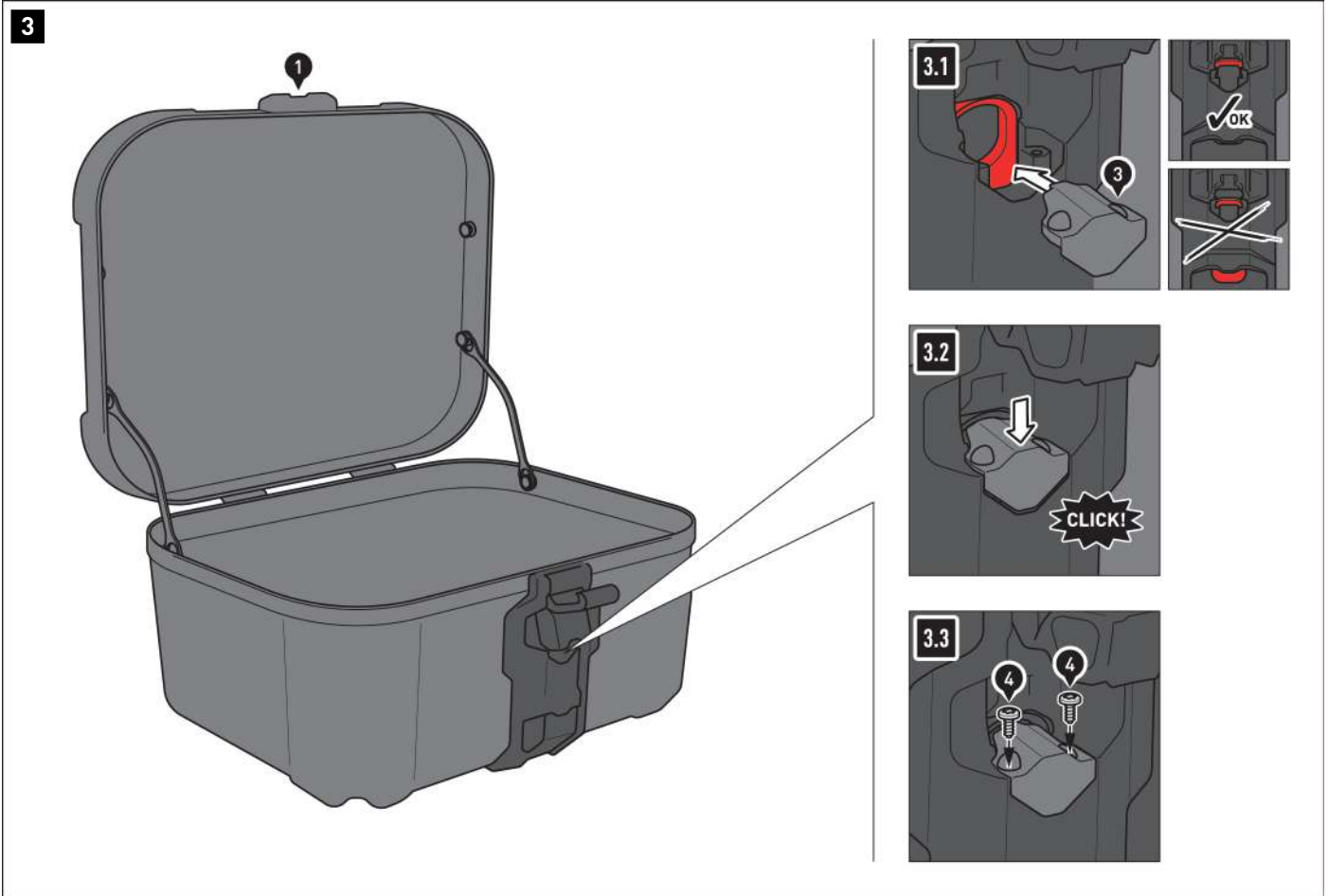

**Installare il connettore dell'alloggiamento della serratura**

**⚠ AVVISIO:** se si è optato per il kit serrature per sistemi DUSC, questa fase di montaggio non è necessaria. Procedere piuttosto con il montaggio del kit serratura.

**3.1** - Aprire la chiusura di bloccaggio del sistema DUSC (1) e posizionare il connettore dell'alloggiamento della chiusura (3) come indicato.

**⚠ AVVISIO:** assicurarsi che la linguetta di chiusura sia in posizione di sblocco (verso l'alto)! Se necessario, la linguetta di chiusura deve essere spinta verso l'alto in posizione di sblocco!

**3.2** - Spingere verso il basso il connettore dell'alloggiamento della chiusura (3) finché non scatta in posizione.

**3.3** - Avvitare il connettore dell'alloggiamento della chiusura (3) utilizzando le viti (4) e la chiave torx (5). Serrare le viti a mano con cautela.

**⚠ AVVERTENZA:** un serraggio eccessivo delle viti potrebbe danneggiare l'alloggiamento della serratura!

**⚠ AVVISIO:** controllare il funzionamento del meccanismo di bloccaggio!



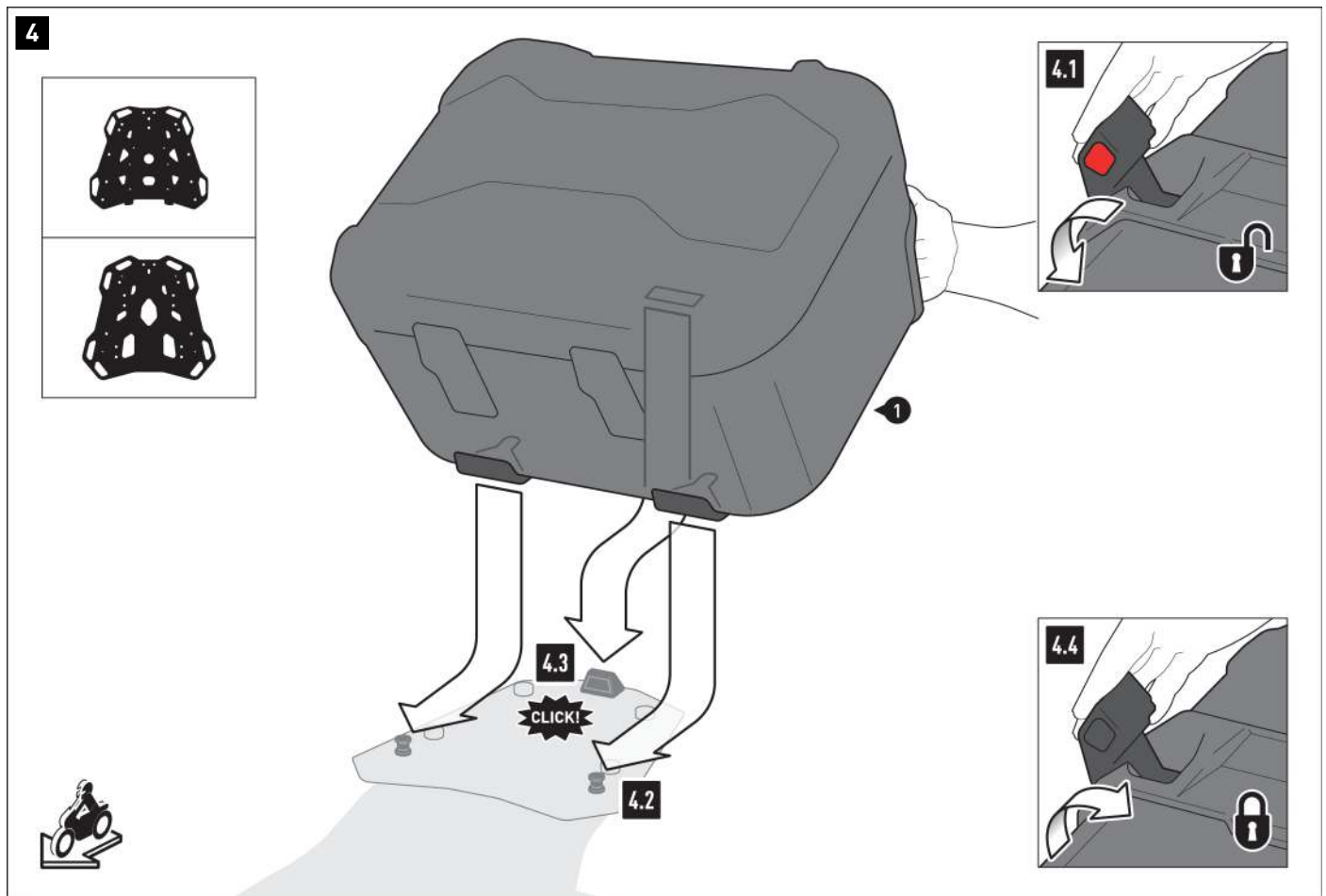

#### Attacco del sistema DUSC come bauletto

**4.1** - Premere il pulsante di rilascio del sistema DUSC (1) e tirare la chiusura di bloccaggio del sistema di bloccaggio in posizione aperta.

**4.2** - Premere il DUSC (1) con i due fori di bloccaggio rivolti sui funghi di contenimento del portabagagli SW-MOTECH.

**4.3** - Premere il DUSC (1) con il foro di bloccaggio rivolto sul nottolino della serratura del portabagagli SW-MOTECH.

**▲ AVVERTENZA: prestare attenzione al clic di innesto udibile!**

**4.4** - Premere la chiusura di bloccaggio del sistema di bloccaggio in posizione di chiusura.

**▲ AVVERTENZA: controllare che il sistema DUSC sia adeguatamente fissato!**

**▲ AVVERTENZA: assicurarsi che nessun componente del sistema DUSC (1) possa entrare in contatto con altre parti calde e mobili del veicolo! Assicurarsi inoltre che tutti i componenti si trovino ad almeno 5 cm di distanza dalle parti calde e dal flusso di gas di scarico! Una volta terminato il montaggio, assicurarsi che tale distanza sia mantenuta indipendentemente dallo stato delle sospensioni del veicolo!**

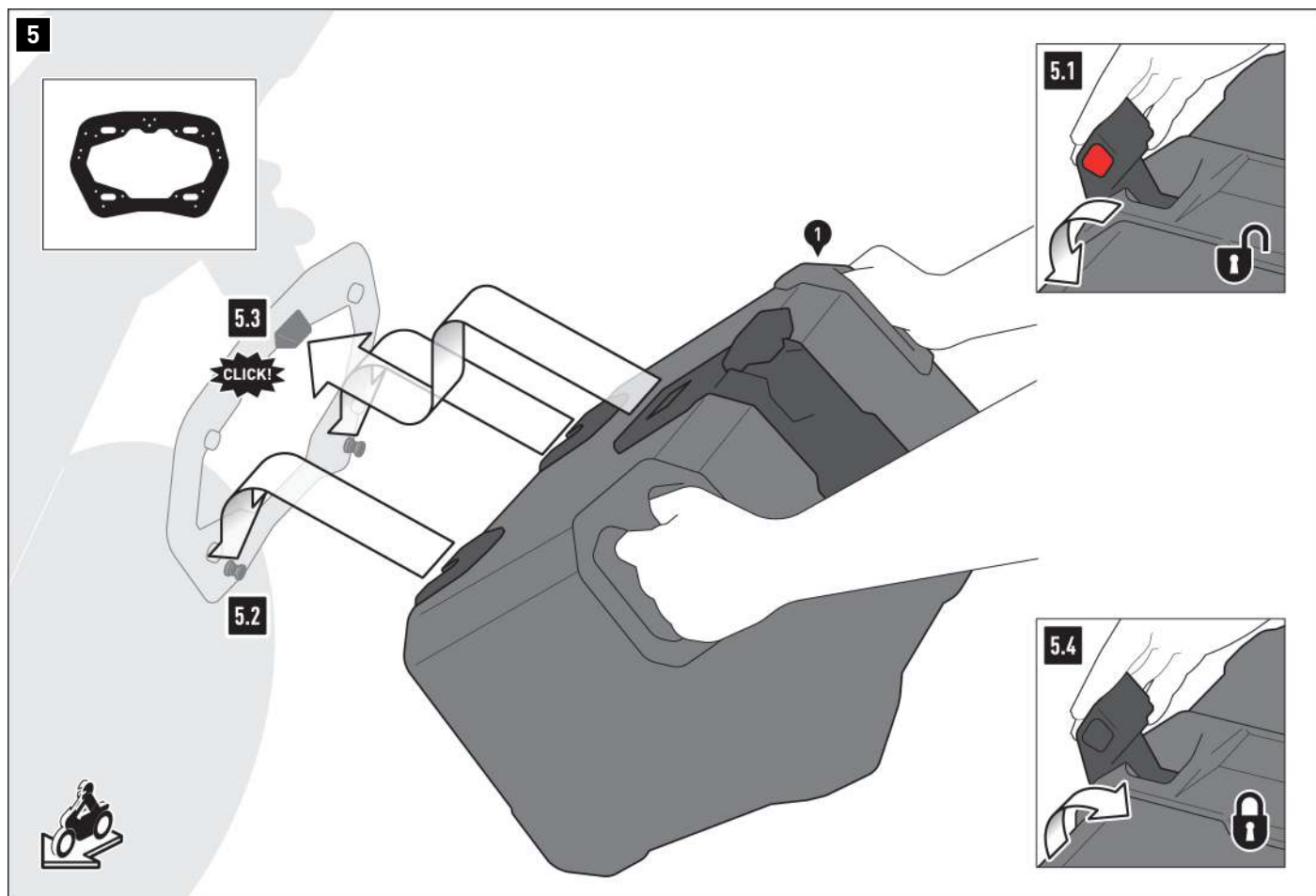

#### Fissaggio del sistema DUSC come valigia laterale

**5.1** - Premere il pulsante di rilascio del sistema DUSC (1) e tirare la chiusura di bloccaggio del sistema di chiusura in posizione aperta.

**5.2** - Premere il DUSC (1) con i due fori di bloccaggio rivolti sui funghi di contenimento del telaio laterale SW-MOTECH.

**5.3** - Premere il DUSC (1) con l'apertura di bloccaggio rivolta sul nottolino della serratura del telaio laterale SW-MOTECH.

**▲ AVVERTENZA: prestare attenzione al clic di innesto udibile!**

**5.4** - Premere la chiusura di bloccaggio del sistema di chiusura in posizione di chiusura.

**▲ AVVERTENZA: controllare che il sistema DUSC sia adeguatamente fissato!**

**▲ AVVERTENZA: assicurarsi che nessun componente del sistema DUSC (1) possa entrare in contatto con altre parti calde e mobili del veicolo! Assicurarsi inoltre che tutti i componenti si trovino ad almeno 5 cm di distanza dalle parti calde e dal flusso di gas di scarico! Una volta terminato il montaggio, assicurarsi che tale distanza sia mantenuta indipendentemente dallo stato delle sospensioni del veicolo!**



6

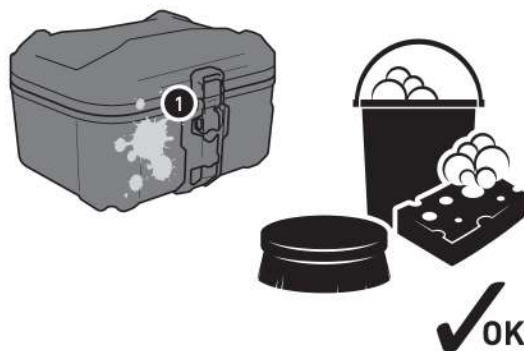
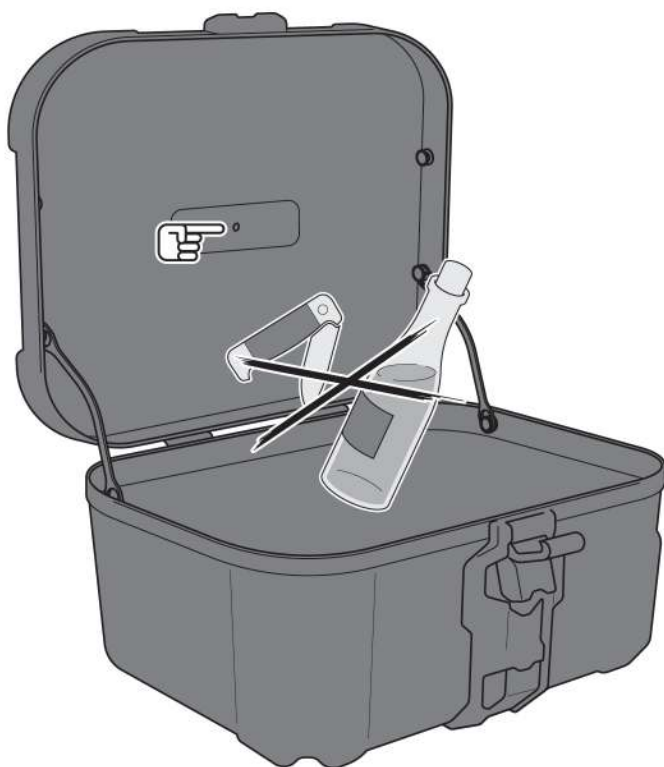

**Carico**

**⚠ AVVERTENZA:** assicurarsi che il carico sia distribuito in modo uniforme! Assicurarsi che il carico sia assicurato contro lo scivolamento durante la guida!

**⚠ AVVISO:** assicurarsi di non trasportare mai oggetti affilati, appuntiti o simili che potrebbero causare lesioni alle persone o danni al veicolo/DUSC! Prestare particolare attenzione a non danneggiare la membrana sovrappressione integrata nel coperchio!

**Cura**

Per la pulizia, utilizzare ESCLUSIVAMENTE una spazzola morbida per tessuti, un panno o una spugna imbevuta di acqua calda e sapone! Quindi risciacquare con acqua pulita.

NON utilizzare detergenti aggressivi, utensili per la pulizia ruvidi o un'idropulitrice! Assicurarsi di pulire il sistema DUSC dopo gli spostamenti in inverno per evitare i danni causati dal sale.

**⚠ AVVISO:** i materiali delle superfici possono subire variazioni di colore (scolorimento) in caso di prolungata e intensa esposizione ai raggi solari e agli agenti ambientali (ad es. SMOG, piogge acide, ecc.)! SW-MOTECH non si assume alcuna responsabilità al riguardo!

**AVVERTENZE SPECIFICHE DEL PRODOTTO**

**⚠ AVVISO:** Osservare le normative specifiche del paese per l'immatricolazione/il funzionamento del veicolo o le norme TÜV applicabili. Dopo l'assemblaggio, far inserire le parti soggette a omologazione nei documenti del veicolo dal proprio centro di test.

**⚠ PERICOLO:** prima di mettersi in viaggio, eseguire un controllo completo di tutte le funzionalità!

**⚠ PERICOLO:** prima di mettersi in viaggio e ad ogni fermata intermedia (ogni 200 km), verificare il corretto posizionamento del prodotto!

**⚠ PERICOLO:** il comportamento di guida e il controllo della frenata della moto cambiano sensibilmente dopo il montaggio di questo prodotto!

**⚠ PERICOLO:** questo prodotto può limitare l'angolo di inclinazione e la distanza dal suolo!

**⚠ PERICOLO:** applicare il carico massimo del veicolo specificato dal costruttore del veicolo!



≤ 10 kg (≤ 22 libbre)



≤ 130 km/h (≤ 80mph)

Art.-Nr.: LOC.00.745.10000

Revision: 00 · Datum: 08 - 2023

## Schloss-Satz für DUSC

 ~ 0.25 h.LEICHT     SCHWER

**DEUTSCH** - Vielen Dank, dass Sie sich für dieses Premium-Produkt von SW-MOTECH entschieden haben. Besuchen Sie unseren Webshop für weitere Informationen (z. B. Modellzuweisungen). Erforderliche Dokumente (z. B. ABE) stehen Ihnen dort als Download zur Verfügung.

Bitte lesen und verstehen Sie alle Anweisungen, Sicherheitshinweise und Warnungen in dieser Anbauanleitung vor Montage und Nutzung des Produkts, um Verletzungen und Schäden zu vermeiden. Bewahren Sie diese Anbauanleitung als Referenz auf.

Dieses Produkt wurde für Fahrzeuge im Werkzustand entwickelt. Die Kompatibilität mit Original-Zubehörteilen bzw. den Zubehörteilen anderer Hersteller kann nicht gewährleistet werden.

Diese Anbauanleitung ist nach unserem derzeitigen Kenntnisstand verfasst worden. Rechtliche Ansprüche auf Richtigkeit bestehen nicht. Fehler und Irrtümer vorbehalten. Technische und gestalterische Änderungen sind vorbehalten. Das Urheberrecht liegt bei SW-MOTECH.

## SICHERHEITSWARNUNGSSYMBOL

 Dieses Warnsymbol wird in dieser Anbauanleitung verwendet, um vor tödlichen Gefahren, Verletzungen oder anderen Gefahren zu warnen. Die Wörter **GEFAHR**, **WARNUNG** oder **VORSICHT** werden mit diesem Warnsymbol verwendet, um wichtige Sicherheitshinweise und Informationen in Bezug auf die Montage und Nutzung dieses Produkts zu übermitteln. Diese Wörter zusammen mit dem Sicherheitswarnsymbol bedeuten:

 **GEFAHR:** Weist auf eine gefährliche Situation hin, die zum Tod oder zu schweren Verletzungen führt, wenn sie nicht vermieden wird!

 **WARNUNG:** Weist auf eine gefährliche Situation hin, die zum Tod oder zu schweren Verletzungen führen kann, wenn sie nicht vermieden wird!

 **VORSICHT:** Weist auf eine gefährliche Situation hin, die zu leichten oder mittelschweren Verletzungen führen kann, wenn sie nicht vermieden wird!

 **HINWEIS:** Wichtige Informationen, jedoch nicht in Bezug auf Todes- oder Verletzungsgefahr (nur Sachschäden)!

## ALLGEMEINE HINWEISE

 **WARNUNG:** Die Montage und/oder Wartung dieses Produkts erfordert fortgeschrittene technische Fähigkeiten, geeignetes Werkzeug und ein gutes Verständnis der Werkzeugnutzung und Drehmomentangaben. Zu Ihrer eigenen Sicherheit empfiehlt SW-MOTECH, die Montage und/oder Wartung von einer qualifizierten und zertifizierten Zweiradwerkstatt durchführen zu lassen.

 **WARNUNG:** Wenn Sie sich für die Eigenmontage dieses Produkts entscheiden, lesen Sie vor Montage und Nutzung die Anbauanleitung sorgfältig und vollständig durch und befolgen Sie alle Anweisungen, um schwere oder tödliche Verletzungen zu vermeiden. Beachten Sie bei der Montage und Verwendung auch alle relevanten Informationen im Fahrzeughandbuch. **WENN SIE EINEN TEIL DIESER ANBAUANLEITUNG NICHT VERSTEHEN ODER EINE ERKLÄRUNG EINER ANWEISUNG BENÖTIGEN, VERSUCHEN SIE NICHT DIESES PRODUKT ZU MONTIEREN, OHNE SW-MOTECH UM HILFE ZU FRAGEN!**

**VORBEREITUNG:** Lesen Sie die Anbauanleitung aufmerksam und stellen Sie sicher, dass alle Teile der Stückliste vorhanden sind.

 **VORSICHT:** Achten Sie auf den sicheren Stand Ihres Fahrzeugs. Schalten Sie den Motor ab und ziehen Sie den Zündschlüssel. Lassen Sie den Motor/Auspuff bei Bedarf abkühlen. Klemmen Sie die Batterie bei Arbeiten an der Elektrik ab. Verwenden Sie nur geeignetes Werkzeug und tragen Sie während der Montage und Wartung immer eine Schutzbrille und Handschuhe. Lassen Sie sich bei der Montage und Wartung von einer zweiten Person helfen.

**MONTAGE:** Alle vom Fahrzeug entfernten Teile und Verbindungen müssen gemäß den Angaben des Fahrzeugherstellers wieder eingebaut oder durch von SW-MOTECH gelieferte Teile und Hardware ersetzt werden.

 **WARNUNG:** Sichern Sie alle Gewinde, sofern nicht anders angegeben, mit mittelstarker, flüssiger Schraubensicherung.

 **GEFAHR:** Von SW-MOTECH nicht definierte Anzugsdrehmomente müssen Sie vom Fahrzeughersteller oder von einer zertifizierten Motorradwerkstatt beziehen.

**FUNKTIONSKONTROLLE:** Stellen Sie nach der Montage sicher, dass keine beweglichen Teile blockiert sind und die Funktion des Fahrzeugs nicht gestört wird. Kabel und Schläuche dürfen nicht scheuern und/oder geklemmt werden.

 **WARNUNG:** Führen Sie vor Fahrtbeginn eine umfassende Funktionskontrolle durch. Prüfen Sie nach den ersten 50 km und dann regelmäßig das Anzugsmoment aller Verbindungen und den festen Sitz des Produkts. Montiertes Zubehör kann das Fahrverhalten und die Stabilität des Fahrzeugs verändern.



SW-MOTECH GmbH & Co. KG  
Ernteweg 7-10  
35282 Rauschenberg  
Deutschland



[info@sw-motech.com](mailto:info@sw-motech.com)  
[www.sw-motech.com](http://www.sw-motech.com)



Beachten Sie in dem Abschnitt MONTAGE vorkommenden Symbole und deren Bedeutung. Wenn im Abschnitt MONTAGE die Bezeichnung OEM vorkommt, müssten die Vorgaben des Fahrzeugherstellers beachtet und angewandt werden.



Bei Fragen steht Ihnen unser Kundendienst sowie unsere Distributoren gerne zur Verfügung. Unsere Telefonnummer sowie eine Liste unserer Distributoren finden Sie in unserem Webshop:  
**[www.sw-motech.com](http://www.sw-motech.com)**

STÜCKLISTE - ANBAUANLEITUNG LESEN UND AUFBEWAHREN!

2

1



HSK.00.745.500.04

 1/1

2



T20  
TRX.T20

 1/1

3



ALK.00.165.A63

 2/2

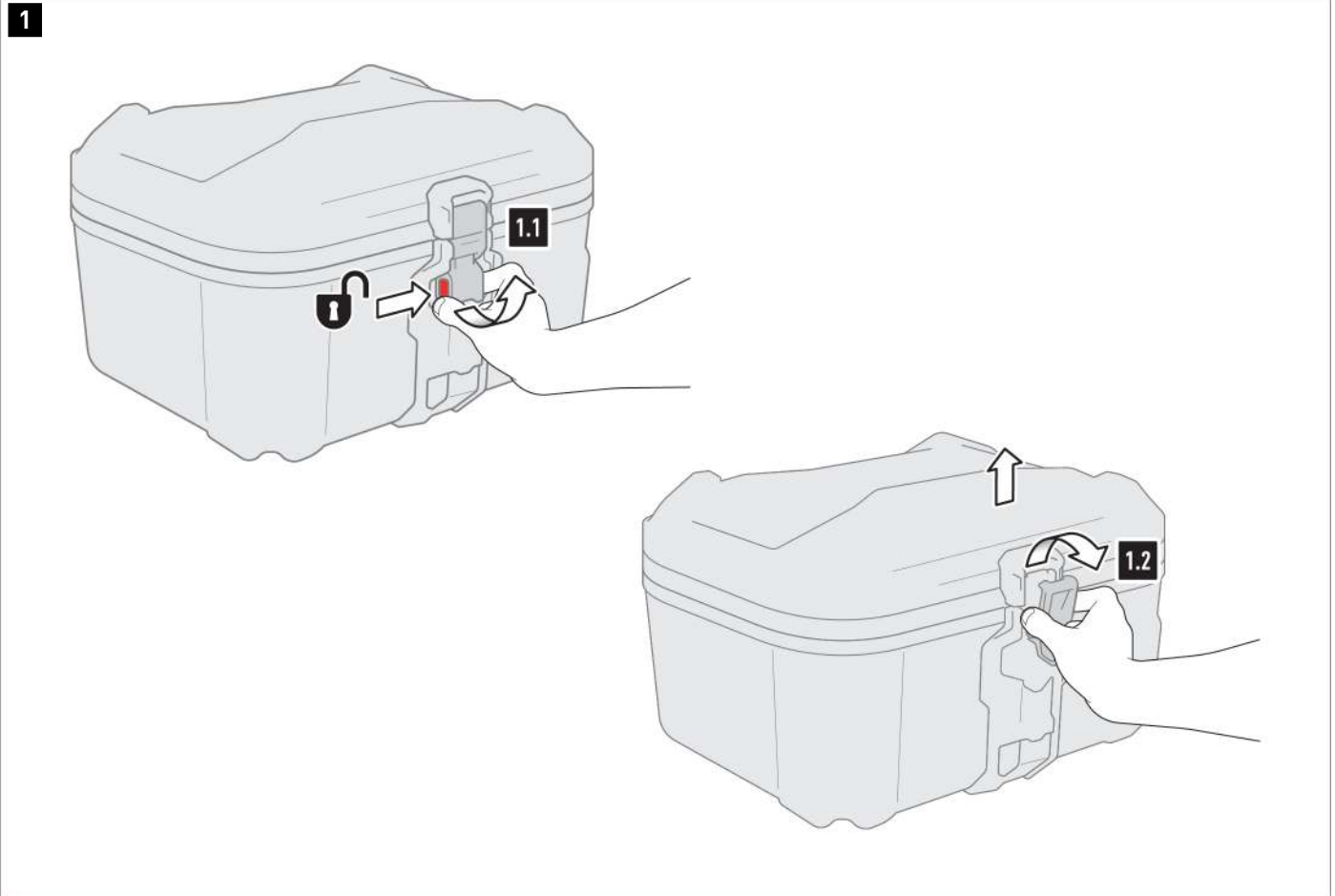

**▲ WARNUNG: Tragen Sie immer Augen- und Handschutz!**  
**▲ WARNUNG: Verwenden Sie immer geeignetes Werkzeug!**

#### Öffnen des Deckels

**1.1** - Drücken Sie den Entriegelungsknopf des DUSC (\*) und ziehen Sie den Spannverschluss des Deckels in die offene Position.

**1.2** - Entfernen Sie den Spannverschluss vom Spannverschlussbügel und öffnen Sie den Deckel.

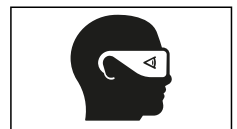

2

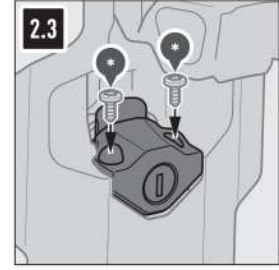
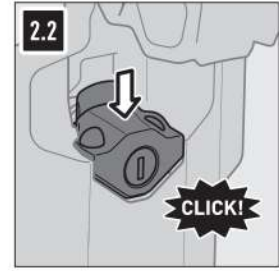
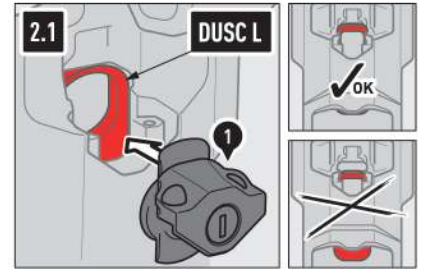

**DUSC-Schloss verbauen**

2.1 - Öffnen Sie den Spannverschluss des DUSC (\*) und positionieren Sie das Schloss (1) wie gezeigt.

**⚠ HINWEIS: NUR DUSC L:** Stellen Sie sicher, dass sich die Schließblase (rot hervorgehoben) in der entriegelten Position befindet (oben)! Gegebenenfalls muss die Schließblase nach oben in die entriegelte Position gedrückt werden!

2.2 - Drücken Sie das Schloss (1) nach unten, bis dieses einrastet.

2.3 - Verschrauben Sie das Schloss (1) mit den dem DUSC beiliegenden Schrauben (\*) und dem Torxschlüssel (2). Ziehen Sie die Schrauben vorsichtig und handfest an.

**⚠ WARNUNG: Ein zu festes Anziehen der Schrauben kann das Schlossgehäuse beschädigen!**

**⚠ HINWEIS:** Überprüfen Sie die Funktion des Verriegelungsmechanismus!

**⚠ HINWEIS:** NIEMALS den Schließzylinder mit Öl schmieren! Verwenden Sie nur Graphitpulver!



**PRODUKTSPEZIFISCHE HINWEISE**

**⚠ HINWEIS:** Beachten Sie die landesspezifischen Vorschriften für Zulassung/Betrieb Ihres Fahrzeugs bzw. anwendbare TÜV-Vorschriften. Lassen Sie eintragungspflichtige Teile nach Montage durch Ihre Prüfstelle in die Fahrzeugpapiere eintragen.



Item number: **LOC.00.745.10000**Revision: **00** · Date: **08 - 2023****Hard case lock set** ~ 0.25 h.EASY      DIFFICULT

**ENGLISH** Thank you for choosing this premium product from SW-MOTECH. Visit our online shop for more information (e.g. model assignments). Required documents (e.g. national type approval) are available there for you to download.

Please read and understand all the instructions, safety information and warnings in these mounting instructions before mounting and using the product in order to avoid injury and damage. Keep these mounting instructions for reference.

This product was developed for vehicles in factory condition. Compatibility with original accessories or accessories from other manufacturers cannot be guaranteed.

These mounting instructions have been prepared to the best of our current knowledge. No legal claims relating to accuracy can be made. Errors and omissions excepted. We reserve the right to make technical and design changes. The copyright is held by SW-MOTECH.

**SAFETY WARNING SYMBOL**

 This warning symbol is used in these mounting instructions to warn of deadly dangers, injuries or other hazards. The words **DANGER**, **WARNING** or **CAUTION** are used as part of this warning symbol to convey important safety messages and information relating to the installation and use of this product. These words, together with the safety warning symbol, mean:

 **DANGER:** Indicates a hazardous situation which, if not avoided, will result in death or serious injury!

 **WARNING:** Indicates a hazardous situation which, if not avoided, may result in death or serious injury!

 **CAUTION:** Indicates a hazardous situation which, if not avoided, may result in minor or moderate injury!

 **NOTE:** Important information, but not relating to a risk of death or injury (property damage only)!

**GENERAL INFORMATION**

 **WARNING:** Assembly and/or maintenance of this product requires advanced technical skill, appropriate tools, and a good understanding of tool usage and torque specifications. For your own safety, SW-MOTECH recommends having the assembly and/or maintenance carried out by a qualified and certified motorcycle workshop.

 **WARNING:** If you do choose to assemble this product yourself, carefully and fully read the mounting instructions before assembly and use, and follow all instructions to avoid serious injury or death. Also observe all relevant information in the vehicle manual when mounting or using the product. IF YOU DO NOT UNDERSTAND ANY PART OF THESE MOUNTING INSTRUCTIONS OR NEED AN EXPLANATION AS TO A SPECIFIC INSTRUCTION, DO NOT ATTEMPT TO INSTALL THIS PRODUCT WITHOUT CONSULTING SW-MOTECH FOR ASSISTANCE!

**PREPARATION:** Read the mounting instructions carefully and make sure that all parts on the parts list are available.

 **CAUTION:** Ensure that your vehicle is standing securely. Switch off the engine and remove the ignition key. Allow the engine/exhaust to cool down if necessary. Disconnect the battery when working on the electrical system. Only use proper tools and always wear safety goggles and gloves during assembly and maintenance. Have a second person help you with assembly and maintenance.

**ASSEMBLY:** All parts and connections removed from the vehicle must be reinstalled according to the vehicle manufacturer's specifications or replaced with parts and hardware supplied by SW-MOTECH.

 **WARNING:** Secure all threads with a medium-strength liquid threadlocker, unless otherwise specified.

 **DANGER:** Tightening torques not defined by SW-MOTECH must be obtained from the vehicle manufacturer or a certified motorbike workshop.

**FUNCTIONAL CHECK:** After mounting the product, ensure that no moving parts are obstructed and that the function of the vehicle is not impeded. Cables and hoses must not rub against each other and/or be hindered in any way.

 **WARNING:** Carry out a comprehensive functionality check before you start to drive. Check the tightening torque of all connections and the tight fit of the product after the first 50 km and then at regular intervals. Mounted accessories can change the handling and stability of the vehicle.



SW-MOTECH GmbH & Co. KG  
Ernteweg 7-10  
35282 Rauschenberg  
Germany



 [info@sw-motech.com](mailto:info@sw-motech.com)  
 [www.sw-motech.com](http://www.sw-motech.com)



Take note of the symbols and what they mean in the ASSEMBLY section. If the term OEM appears in the ASSEMBLY section, the vehicle manufacturer's specifications must be observed and applied.



If you have any questions, please don't hesitate to contact our Customer Service team or our distributors. You can find our telephone number and a list of our distributors in our online shop:

**[www.sw-motech.com](http://www.sw-motech.com)**

**PARTS LIST - READ AND KEEP MOUNTING INSTRUCTIONS!**

**2**

**1**



HSK.00.745.500.04

 **1/1**

**2**



T20  
TRX.T20

 **1/1**

**3**



ALK.00.165.A63

 **2/2**



**⚠ WARNING: Always wear eye and hand protection!**  
**⚠ WARNING: Always use the proper tools!**

**Opening the lid**

**1.1** - Press the DUSC release button (\*) and pull the lid latch buckle into the open position.

**1.2** - Remove the latch buckle from the corresponding bracket and open the lid.



2

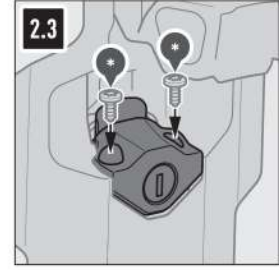
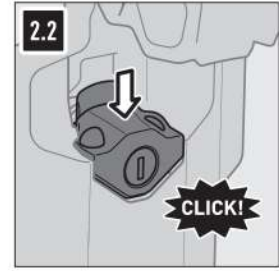
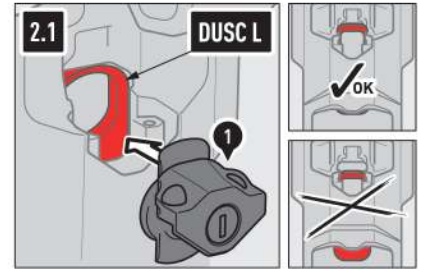

**Install DUSC lock**

**2.1** - Open the DUSC (\*) latch buckle and position the lock (1) as shown.  
 ⚠ **NOTE: DUSC L ONLY:** Make sure the locking tab (highlighted in red) is in the unlocked position (up)! If necessary, the locking tab must be pushed up into the unlocked position!

**2.2** - Push the lock (1) down until it clicks into place.

**2.3** - Screw in the lock (1) using the screws (\*) supplied with the DUSC and the torx key (2). Carefully tighten the screws by hand.

⚠ **WARNING: Over-tightening the screws may damage the lock casing!**

⚠ **NOTE:** Ensure that the locking mechanism is in working order!

⚠ **NOTE:** NEVER lubricate the lock cylinder with oil! Only use graphite powder!



**PRODUCT-SPECIFIC NOTES**

**⚠ NOTE:** *Observe the country-specific regulations for the registration/operation of your vehicle or applicable TÜV regulations. After assembly, have parts that are subject to registration entered in the vehicle documents by your test centre.*

Número de artículo: **LOC.00.745.10000**Revisión: **00** · Fecha: **08 - 2023****Juego de bombín para maletín rígido** ~ 0.25 h.**FÁCIL**     **COMPLICADO**

**ESPAÑOL** · Gracias por elegir este producto de primera calidad de SW-MOTECH. Visite nuestra tienda online para obtener más información (p. ej., sobre el uso de los modelos). Desde esa página podrá descargar los documentos que necesite (por ejemplo, la homologación nacional de tipo).

Para evitar lesiones y daños, asegúrese de leer y comprender todas las instrucciones, advertencias de seguridad y precauciones de este manual antes de montar y utilizar el producto. Guarde estas instrucciones de montaje como referencia.

Este producto ha sido desarrollado para vehículos en condiciones de fábrica. No se garantiza la compatibilidad con los accesorios originales o de otros fabricantes.

Estas instrucciones de montaje se han redactado de acuerdo con nuestros conocimientos actuales. No hay reclamaciones legales de corrección. Salvo errores y omisiones. Nos reservamos el derecho a realizar cambios técnicos y de diseño. Los derechos de autor pertenecen a SW-MOTECH.

**SÍMBOLO DE ADVERTENCIA DE SEGURIDAD**

 Este símbolo de advertencia se utiliza en estas instrucciones de montaje para advertir de peligros mortales, lesiones u otros riesgos. Las palabras **PELIGRO**, **ATENCIÓN** o **PRECAUCIÓN** se utilizan con este símbolo de advertencia para transmitir importantes avisos de seguridad e información relacionada con el montaje y uso de este producto. Estas palabras, junto con el símbolo de advertencia de seguridad, significan:

 **PELIGRO:** Indica una situación de peligro que, si no se evita, provoca lesiones graves o incluso la muerte.

 **ATENCIÓN:** Indica una situación de peligro que, si no se evita, puede provocar lesiones graves o incluso la muerte.

 **PRECAUCIÓN:** Indica una situación de peligro que, si no se evita, puede provocar lesiones leves o de gravedad media.

 **NOTA:** Información importante, pero que no está relacionada con un riesgo de lesiones o muerte (solo daños materiales).

**INDICACIONES GENERALES**

 **ATENCIÓN:** El montaje y/o mantenimiento de este producto requiere conocimientos técnicos avanzados, las herramientas apropiadas, un buen manejo de dichas herramientas y conocer las especificaciones de los pares de apriete. Por su propia seguridad, SW-MOTECH recomienda que el montaje y/o el mantenimiento los realice un taller de motocicletas cualificado y certificado.

 **ATENCIÓN:** Si elige ensamblar este producto usted mismo, antes de montarlo y usarlo, lea las instrucciones de montaje detenidamente y en su totalidad, y siga todas las indicaciones para evitar lesiones graves o mortales. Cuando monte y utilice el producto, tenga también en cuenta toda la información relevante que figure en el manual del vehículo. **SI NO ENTIENDE ALGUNA PARTE DE ESTAS INSTRUCCIONES DE MONTAJE O NECESITA ALGUNA ACLARACIÓN, NO INTENTE INSTALAR ESTE PRODUCTO SIN CONSULTAR A SW-MOTECH PARA OBTENER AYUDA.**

**PREPARACIÓN:** Lea atentamente las instrucciones de montaje y asegúrese de que todas las piezas de la lista de piezas están presentes.

 **PRECAUCIÓN:** Asegúrese de que su vehículo esté estacionado de manera segura. Apague el motor y retire la llave de encendido. Deje que el motor o el escape se enfrien si es necesario. Desconecte la batería cuando trabaje en el sistema eléctrico. Utilice únicamente las herramientas adecuadas y use siempre gafas de seguridad y guantes al realizar el montaje y las tareas de mantenimiento. Pida a otra persona que le ayude con el montaje y el mantenimiento.

**MONTAJE:** Todas las piezas y conexiones retiradas del vehículo deben ser reinstaladas de acuerdo con las especificaciones del fabricante del vehículo o sustituidas por piezas y herrajes suministrados por SW-MOTECH.

 **ATENCIÓN:** Asegure todas las roscas con fijador de roscas líquido de resistencia media, a menos que se especifique lo contrario.

 **PELIGRO:** Los pares de apriete no definidos por SW-MOTECH deben obtenerse del fabricante del vehículo o de un taller de motocicletas certificado.

**COMPROBACIÓN FUNCIONAL:** Después del montaje, asegúrese de que no haya piezas móviles bloqueadas y de que no se altere el funcionamiento del vehículo. Los cables y tubos no deben rozarse ni quedar pinzados.

 **ATENCIÓN:** Realice una comprobación exhaustiva del funcionamiento antes de iniciar la marcha. Tras los primeros 50 km y, después, con regularidad, compruebe el par de apriete de todas las conexiones y que el producto está firmemente sujeto. Los accesorios instalados pueden cambiar el comportamiento de conducción y la estabilidad del vehículo.



SW-MOTECH GmbH & Co. KG  
Ernteweg 7-10  
35282 Rauschenberg  
Alemania



[info@sw-motech.com](mailto:info@sw-motech.com)  
[www.sw-motech.com](http://www.sw-motech.com)



Preste atención a los símbolos que figuran en la sección de MONTAJE y su significado. Cuando, en la sección de MONTAJE, aparecen las siglas OEM, se deberán seguir y aplicar las especificaciones del fabricante del vehículo.



Si tiene alguna pregunta, nuestro servicio de atención al cliente y nuestros distribuidores estarán encantados de prestarle ayuda. Encontrará nuestro número de teléfono y una lista de nuestros distribuidores en nuestra tienda online:

**[www.sw-motech.com](http://www.sw-motech.com)**



LISTA DE PIEZAS - LEE Y CONSERVA LAS INSTRUCCIONES DE MONTAJE!

2

1



HSK.00.745.500.04

 1/1

2



T20  
TRX.T20

 1/1

3



ALK.00.165.A63

 2/2

1



- ⚠ **ATENCIÓN:** ¡Use siempre protección de ojos y manos!
- ⚠ **ATENCIÓN:** ¡Utilice siempre herramientas adecuadas!

#### Apertura de la tapa

- 1.1. Presione el botón de liberación del DUSC (\*) y tire del obturador de tensión de la tapa para abrirlo.
- 1.2. Retire el obturador de tensión del enganche y abra la tapa.

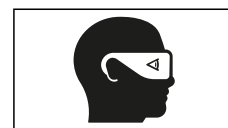

2

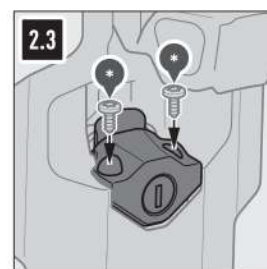
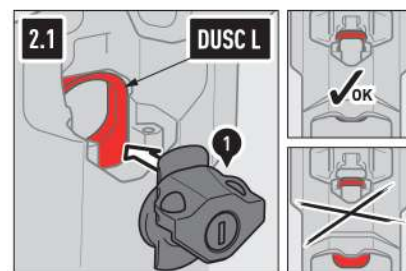

**Instalación de la cerradura del DUSC**

2.1. Abra el obturador de tensión del DUSC (\*) y coloque la cerradura (1) como se muestra en la imagen.

**⚠ NOTA: SOLO PARA EL DUSC L:** ¡Asegúrese de que la lengüeta de bloqueo (resaltada en rojo) esté desbloqueada (hacia arriba)! Si es necesario, la lengüeta de bloqueo debe empujarse hacia arriba para colocarla en la posición de desbloqueo.

2.2. Empuje la cerradura (1) hacia abajo hasta que encaje en su lugar.

2.3. Atornille la cerradura (1) utilizando los tornillos (\*) suministrados con el DUSC y la llave torx (2). Apriete los tornillos a mano con cuidado.

**⚠ ATENCIÓN:** ¡Apretar demasiado los tornillos puede dañar la caja de la cerradura!

**⚠ NOTA:** Compruebe el funcionamiento del mecanismo de bloqueo.

**⚠ NOTA:** ¡NUNCA lubrique el bombín con aceite! ¡Utilice únicamente polvo de grafito!



**INDICACIONES ESPECÍFICAS DEL PRODUCTO**

**⚠ NOTA:** *Tenga en cuenta las normas específicas del país para la matriculación/uso de su vehículo o las normas aplicables de la ITV. En caso de piezas con registro obligatorio, su organismo de inspección debe registrarlas tras el montaje en los documentos del vehículo.*

Numéro d'article: **LOC.00.745.10000**Révision: **00** · Date: **08 - 2023****Kit de serrures pour valises rigides** ~ 0.25 h.FACILE      DIFFICILE

**FRANÇAIS** · Nous vous remercions d'avoir choisi ce produit haut de gamme de SW-MOTECH. Visitez notre boutique en ligne pour plus d'informations (par exemple affectation des modèles). Les documents nécessaires (par exemple ABE) y sont disponibles en téléchargement.

**Veillez lire et prendre en compte toutes les instructions, les consignes de sécurité et les avertissements contenus dans ce manuel de montage avant de monter et d'utiliser le produit afin d'éviter toute blessure ou tout dommage. Veuillez conserver la notice d'utilisation pour référence.**

**Ce produit a été développé pour des véhicules en configuration d'usine. Nous ne sommes pas en mesure d'assurer la compatibilité avec les pièces de rechange originales ou les pièces de rechange d'autres fabricants.**

**La présente notice d'installation a été élaborée conformément à nos connaissances actuelles. Il n'existe aucun droit juridique à l'exactitude des informations qu'elle contient. Sous réserve d'erreurs et de fautes. Sous réserve de modifications techniques et conceptuelles. SW-MOTECH détient les droits d'auteur.**

**SYMBOLE D'AVERTISSEMENT DE SÉCURITÉ**

 Ce symbole d'avertissement est utilisé dans ces instructions de montage pour mettre en garde contre des dangers mortels, de blessures ou d'autres risques. Les mots **DANGER**, **ATTENTION** ou **RECOMMANDATION** sont utilisés avec ce symbole d'avertissement pour transmettre des consignes de sécurité et des informations importantes concernant le montage et l'utilisation de ce produit. Ces mots, associés au symbole d'avertissement de sécurité, signifient :

 **DANGER** : signale une situation dangereuse pouvant entraîner la mort ou des blessures graves si elle n'est pas évitée !

 **ATTENTION** : signale une situation dangereuse pouvant entraîner la mort ou des blessures graves si elle n'est pas évitée !

 **PRUDENCE** : Indique une situation dangereuse susceptible d'entraîner des blessures de gravité réduite ou moyenne si elle se présente !

 **REMARQUE** : Informations importantes, mais qui n'entraînent pas de risque de décès ou de blessure (dommages matériels uniquement).

**REMARQUES GÉNÉRALES**

 **ATTENTION** : le montage et/ou l'entretien de ce produit nécessite des compétences techniques avancées, des outils appropriés et une bonne compréhension de l'utilisation des outils et des indications de réglage. Pour votre propre sécurité, SW-MOTECH recommande de confier le montage et/ou l'entretien à un atelier de réparation de deux-roues qualifié et certifié.

 **ATTENTION** : si vous décidez de monter vous-même ce produit, lisez attentivement et intégralement les instructions de montage avant le montage et l'utilisation et suivez toutes les instructions afin d'éviter des blessures graves ou mortelles. Lors du montage et de l'utilisation, tenez également compte de toutes les informations pertinentes du manuel du véhicule. **SI VOUS NE COMPRENEZ PAS UNE PARTIE DE CE MANUEL D'INSTALLATION OU SI VOUS AVEZ BESOIN D'EXPLICATIONS CONCERNANT UNE INSTRUCTION, N'ESSAYEZ PAS D'INSTALLER CE PRODUIT SANS DEMANDER DE L'AIDE À SW-MOTECH !**

**PRÉPARATION** : Veuillez lire attentivement les instructions de montage et assurez-vous que tous les éléments de la liste de pièces sont présents.

 **PRUDENCE** : veillez à ce que votre véhicule soit bien stable. Éteignez le moteur et retirez la clé de contact. Laissez refroidir le moteur/l'échappement si nécessaire. Débranchez la batterie lorsque vous travaillez sur le système électrique. Utilisez uniquement des outils appropriés et portez toujours des lunettes de protection et des gants pendant le montage et l'entretien. Faites-vous aider par une deuxième personne lors du montage et de l'entretien.

**MONTAGE** : Toutes les pièces et connexions retirées du véhicule doivent être réinstallées conformément aux instructions du fabricant du véhicule ou remplacées par des pièces et du matériel fournis par SW-MOTECH.

 **ATTENTION** Sauf indication contraire, sécurisez tous les filetages avec du frein filet liquide de force moyenne.

 **DANGER** : Les couples de serrage non définis par SW-MOTECH doivent être obtenus auprès du constructeur du véhicule ou d'un atelier de réparation de motos certifié.



**CONTRÔLE DU FONCTIONNEMENT** : Après le montage, assurez-vous qu'aucune pièce mobile n'est bloquée et que le fonctionnement du véhicule n'est pas perturbé. Les câbles et les tuyaux ne doivent pas frotter et/ou être coincés.

 **ATTENTION** : Effectuez un contrôle de fonctionnement complet avant de commencer à rouler. Après les 50 premiers kilomètres, puis régulièrement, vérifiez le couple de serrage de tous les raccords et la bonne fixation du produit. Les accessoires montés peuvent modifier le comportement sur la route et la stabilité du véhicule.



SW-MOTECH GmbH & Co. KG  
Ernteweg 7-10  
35282 Rauschenberg  
Allemagne



 [info@sw-motech.com](mailto:info@sw-motech.com)  
 [www.sw-motech.com](http://www.sw-motech.com)



Vous trouverez les symboles et leur signification dans la section MONTAGE. Si le terme OEM apparaît dans la section MONTAGE, il faut respecter et appliquer les consignes du fabricant du véhicule.



Si vous avez des questions, notre service clientèle ainsi que nos distributeurs se tiennent à votre disposition. Vous trouverez notre numéro de téléphone ainsi que la liste de nos distributeurs sur notre boutique en ligne : **[www.sw-motech.com](http://www.sw-motech.com)**

LISTE DES PIÈCES - LIRE ET CONSERVER LES INSTRUCTIONS DE MONTAGE!

2

1



HSK.00.745.500.04

 1/1

2



T20  
TRX.T20

 1/1

3



ALK.00.165.A63

 2/2

1



**⚠ ATTENTION : portez toujours des lunettes et des gants de protection !**  
**⚠ ATTENTION : Utilisez toujours des outils appropriés !**

#### Ouverture du couvercle

1.1 - Appuyez sur le bouton de déverrouillage de la DUSC (\*) et placez le verrou du couvercle en position ouverte.

1.2 - Retirez le verrou de son support et ouvrez le couvercle.





2

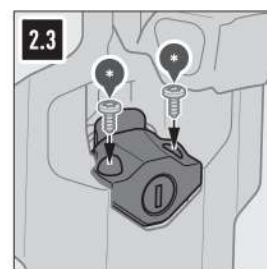

**Montage de la serrure de la DUSC**

2.1 - Ouvrez le verrou de la DUSC (\*) et positionnez la serrure (1) comme indiqué.

**⚠ REMARQUE : DUSC L UNIQUEMENT :** Assurez-vous que la patte de fermeture (indiquée en rouge) est en position déverrouillée (vers le haut) ! Si nécessaire, la patte de fermeture doit être relevée en position déverrouillée !

2.2 - Pressez la serrure (1) vers le bas jusqu'à ce qu'elle s'enclenche.

2.3 - Vissez la serrure (1) à l'aide des vis (\*) et de la clé torx (2) fournies avec la DUSC. Serrez les vis manuellement avec précaution.

**⚠ ATTENTION :** Un serrage excessif des vis peut endommager le boîtier de la serrure !

**⚠ REMARQUE :** Vérifiez le fonctionnement du mécanisme de verrouillage !

**⚠ REMARQUE :** NE JAMAIS lubrifier le cylindre de serrure avec de l'huile ! N'utilisez que de la poudre de graphite !



**REMARQUES SPÉCIFIQUES AU PRODUIT**

**⚠ REMARQUE** : Respectez les réglementations spécifiques au pays pour l'immatriculation/l'exploitation de votre véhicule ou les réglementations TÜV applicables. Après le montage, faites inscrire les pièces soumises à immatriculation dans les papiers du véhicule par votre centre de contrôle.

Numero di articolo: **LOC.00.745.10000**Revisione: **00** · Data: **08 - 2023****Kit serratura bauletti rigidi** ~ 0.25 h.FACILE     DIFFICILE

**ITALIANO** -Grazie per aver scelto questo prodotto premium di SW-MOTECH. Visita il nostro negozio online per ulteriori informazioni (ad es. per la compatibilità con i vari modelli). I documenti richiesti (ad es. certificato di omologazione nazionale) possono essere scaricati qui.

**Si prega di leggere attentamente le avvertenze di sicurezza e le istruzioni per il montaggio prima di montare e utilizzare il prodotto, al fine di evitare eventuali lesioni e danni. Conserva queste istruzioni per il montaggio come riferimento futuro.**

**Questo prodotto è stato sviluppato per veicoli in condizioni di fabbrica. La compatibilità con gli accessori originali o di altri produttori non può essere garantita.**

**Queste istruzioni per il montaggio sono state redatte in base alle nostre conoscenze attuali. Non sussistono pretese di correttezza giuridiche. Salvo errori ed omissioni. Ci riserviamo il diritto di apportare modifiche tecniche e di design. Copyright SW-MOTECH.**

**SIMBOLO DI SICUREZZA**

 Questo simbolo di avvertenza è usato nelle presenti istruzioni di montaggio per segnalare pericoli mortali, rischio di lesioni o altri pericoli. Le parole "PERICOLO", "AVVERTENZA" O "ATTENZIONE" sono utilizzate con questo simbolo di avvertenza per trasmettere importanti istruzioni di sicurezza e informazioni relative al montaggio e all'uso di questo prodotto. Queste parole, utilizzate insieme al simbolo di avvertenza, significano:

**▲ PERICOLO:** indica una situazione di pericolo che, se non evitata, può causare morte o lesioni gravi!

**▲ AVVERTENZA:** indica una situazione di pericolo che, se non evitata, può causare morte o lesioni gravi!

**▲ ATTENZIONE:** indica una situazione di pericolo che, se non evitata, può provocare lesioni lievi o di entità moderata!

**▲ AVVISO:** indica informazioni importanti che non riguardano il rischio di morte o di lesioni (riguardano unicamente il rischio di danni materiali)!

**INFORMAZIONI GENERALI**

**▲ AVVERTENZA:** il montaggio e/o la manutenzione di questo prodotto richiedono competenze tecniche avanzate, strumenti adeguati e una buona conoscenza dell'uso della strumentazione e delle indicazioni relative alle coppie di serraggio. Per ragioni di sicurezza, SW-MOTECH raccomanda di far eseguire il montaggio e/o la manutenzione presso un'officina per motociclette qualificata e certificata.

**▲ AVVERTENZA:** se si decide di installare questo prodotto in autonomia, leggere attentamente le istruzioni per il montaggio prima del montaggio e dell'uso e seguire tutte le avvertenze per evitare lesioni gravi o mortali. Durante il montaggio e l'uso, seguire anche tutte le istruzioni pertinenti contenute nel manuale del veicolo. **SE NON SI COMPRENDONO TALI ISTRUZIONI, ANCHE SOLO IN PARTE, O SE SONO NECESSARI CHIARIMENTI, NON CERCARE DI MONTARE IL PRODOTTO IN AUTONOMIA SENZA CHIEDERE IL SUPPORTO DI SW-MOTECH!**

**PREPARAZIONE:** leggere attentamente le istruzioni per il montaggio e assicurarsi che siano disponibili tutti i componenti contenuti nella lista.

**▲ ATTENZIONE:** assicurarsi che il veicolo sia perfettamente fermo. Spegner il motore e togliere la chiave. Se necessario, lasciar raffreddare il motore/lo scarico. Scollegare la batteria quando si interviene sull'impianto elettrico. Usare esclusivamente strumenti idonei e indossare sempre occhiali e guanti protettivi durante le operazioni di montaggio e manutenzione. Chiedere aiuto a una seconda persona durante le fasi di montaggio e manutenzione.

**MONTAGGIO:** tutti i componenti e i collegamenti rimossi dal veicolo devono essere reinstallati secondo le specifiche del produttore del veicolo o sostituiti con componenti e attrezzatura forniti da SW-MOTECH.

**▲ AVVERTENZA:** fissare tutte le filettature con frenafili liquido a media resistenza, se non diversamente specificato.

**▲ PERICOLO:** le coppie di serraggio non definite da SW-MOTECH devono essere richieste al costruttore del veicolo o a un'officina certificata.

**CONTROLLO DI FUNZIONALITÀ:** dopo il montaggio accertarsi che non vi siano parti mobili bloccate e che il funzionamento del veicolo non sia compromesso. I cavi e i tubi flessibili non devono sfregare e/o essere schiacciati.

**▲ AVVERTENZA:** eseguire un controllo completo delle funzioni prima di mettersi alla guida. Controllare la coppia di serraggio di tutti i collegamenti e la tenuta del prodotto dopo i primi 50 km e in seguito regolarmente. Gli accessori montati possono modificare la maneggevolezza e la stabilità del veicolo.



SW-MOTECH GmbH & Co. KG  
Ernteweg 7-10  
35282 Rauschenberg  
Germania



[info@sw-motech.com](mailto:info@sw-motech.com)  
[www.sw-motech.com](http://www.sw-motech.com)



Consultare i simboli e il loro significato nella sezione MONTAGGIO. Se nella sezione montaggio compare la sigla OEM, è necessario rispettare e applicare le specifiche del produttore del veicolo.



Per qualsiasi domanda, non esitare a contattare il nostro servizio clienti o i nostri distributori. Il nostro numero di telefono e l'elenco dei nostri distributori sono disponibili nel nostro negozio online:  
**[www.sw-motech.com](http://www.sw-motech.com)**

ELENCO DELLE PARTI - LEGGI E CONSERVA LE ISTRUZIONI DI MONTAGGIO!

2

1



HSK.00.745.500.04

 1/1

2



T20  
TRX.T20

 1/1

3



ALK.00.165.A63

 2/2

1

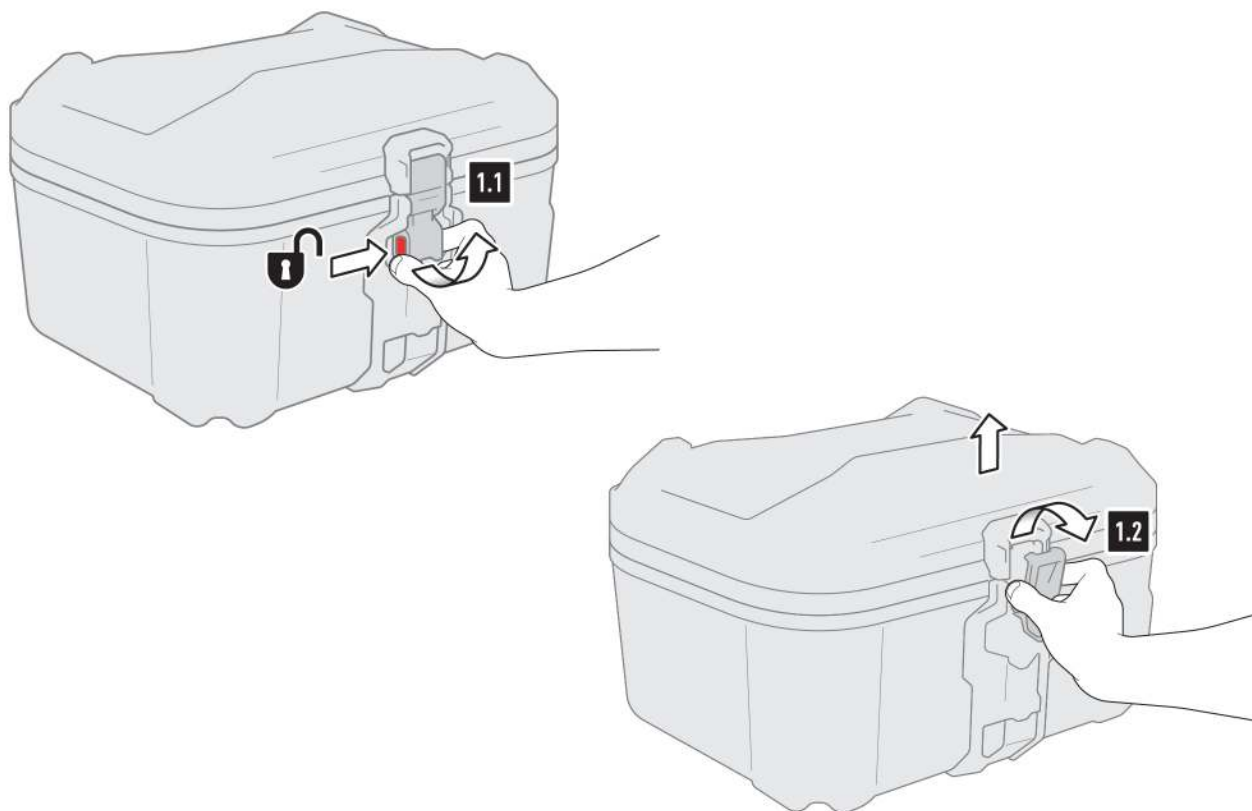

- ▲ AVVERTENZA: indossare sempre le protezioni per gli occhi e per le mani!
- ▲ AVVERTENZA: Utilizzare sempre strumenti adeguati!

#### Apertura del coperchio

1.1 - Premere il pulsante di rilascio del sistema DUSC (\*) e tirare la chiusura di bloccaggio del coperchio in posizione aperta.

1.2 - Rimuovere la chiusura di bloccaggio dalla relativa staffa e aprire il coperchio.

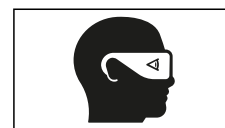

2

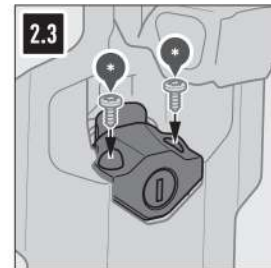
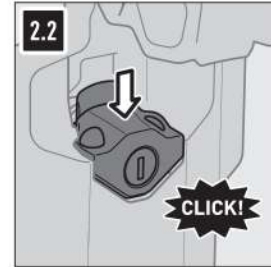
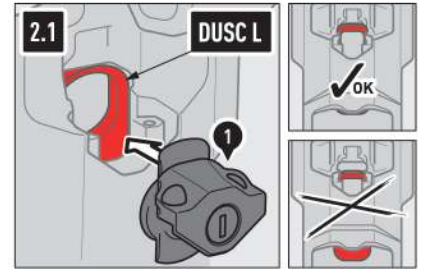

**Installazione della serratura del DUSC**

**2.1** - Aprire la chiusura di bloccaggio del sistema DUSC (\*) e posizionare la serratura (1) come indicato.

**⚠ AVVISIO: SOLO PER DUSC L:** assicurarsi che la linguetta di chiusura (evidenziata in rosso) sia in posizione di sblocco (verso l'alto)! Se necessario, la linguetta di chiusura deve essere spinta verso l'alto in posizione di sblocco!

**2.2** - Spingere la serratura (1) verso il basso fino a innestarla.

**2.3** - Avvitare la serratura (1) utilizzando le chiavi torx (2) e le viti (\*) fornite con il DUSC. Serrare le viti con cura e a mano.

**⚠ AVVERTENZA: un serraggio eccessivo delle viti potrebbe danneggiare l'alloggiamento della serratura!**

**⚠ AVVISIO: controllare il funzionamento del meccanismo di bloccaggio!**

**⚠ AVVISIO: non lubrificare MAI il cilindro di bloccaggio con olio! Utilizzare esclusivamente polvere di grafite!**



**AVVERTENZE SPECIFICHE DEL PRODOTTO**

**⚠ AVVISO** :Rispettare le normative specifiche del paese per l'immatricolazione/l'uso del veicolo o le normative TÜV applicabili. Dopo il montaggio, far inserire le parti soggette a omologazione nei documenti del veicolo dal proprio centro di test.