

## BMW F 650 CS

### Schutzbügel Montagehinweise

Alle vom Motorrad gelösten Schrauben sind gemäß Herstellerangaben wieder zu montieren, oder mit von SW-MOTEC gelieferten Schrauben zu ersetzen. Falls nicht anderweitig definiert, diese Schrauben nach Tabelle anziehen.

M6	9,6 Nm
M8	23 Nm
M10	46 Nm

Gegebenenfalls Schrauben mit flüssiger Schraubensicherung einkleben.

Prüfen Sie nach 50km alle Verbindungen auf festen Sitz.

SW-MOTEC GmbH & Co. KG  
Ernteweg 8/10  
35282 Rauschenberg  
Germany

Tel. +49 (0) 64 25/8 16 8-00  
Fax +49 (0) 64 25/8 16 8-10

info@sw-motech.com  
www.sw-motech.com

### Crashbar Mounting Instructions

SW-MOTEC products should be installed by a qualified, experienced motorcycle technician. If you are unsure of your ability to properly install a product, please have the product installed by your local motorcycle dealer. SW-MOTEC takes no responsibility for damages caused by improper installation.

All screws, bolts and nuts, including all replacement hardware provided by SW-MOTEC, should be tightened to the torque specified in the OEM maintenance manual for your motorcycle. If no torque specifications are provided in the OEM maintenance manual, the following torques may be used:

M6	9,6 Nm
M8	23 Nm
M10	46 Nm

All screws, bolts and nuts should be checked after driving the first 50 km to ensure that all are tightened to the proper torque.

Medium strength liquid thread-locker (i.e., "Loctite") should be used to secure all screws, bolts and nuts.

**! Achtung: die Schräglagenfreiheit kann durch den Schutzbügel reduziert werden!**

**Attention: the lean angle can be reduced by the crash bar!**

1 Schutzbügel  
Crashbar

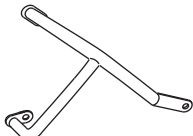

SBL.07.211.901/902

Anzahl/Pcs. 2 (L/R)

5 Distanzbuchse  
Spacer



Da:20 Di:10,5 h:3

Anzahl/Pcs. 1

4 Senkkopfschraube  
Countersunk Screw



M10 x 60 DIN 7991

Anzahl/Pcs. 1

3 Distanzbuchse  
Spacer

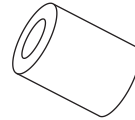

Da:20 Di:10,5 h:24

Anzahl/Pcs. 1

2 Senkkopfschraube  
Countersunkscrew

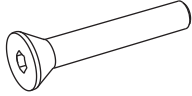

M10 x 80 DIN 7991

Anzahl/Pcs. 1

9 Mutter mit Bund  
Nut



M8 DIN 6927

Anzahl/Pcs. 1

8 Unterlegscheibe  
Washer



A 8,4 DIN 125

Anzahl/Pcs. 1

7 Zylinderschraube  
mit Innensechskant  
Hexagon Socket Screw

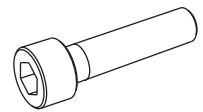

M8 x 80 DIN 912

Anzahl/Pcs. 1

6 Distanzbuchse  
Spacer



Da:15 Di:8,4 h:5

Anzahl/Pcs. 2

16 Distanzbuchse  
Spacer

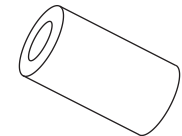

Da:20 Di:10,5 h:50

Anzahl/Pcs. 1

17 Innensechskantschraube  
Hexagon Socket Screw

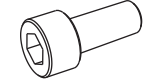

M5 x 16 DIN 912

Anzahl/Pcs. 5

11 Distanzbuchse  
Spacer



Da:20 Di:5,3 h:3

Anzahl/Pcs. 6

10 Innensechskantschraube  
Hexagon Socket Screw

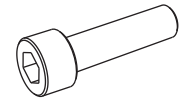

M5 x 40 DIN 912

Anzahl/Pcs. 1

15 Distanzbuchse  
Spacer

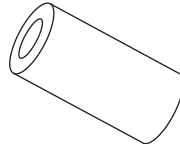

Da:20 Di:10,5 h:61

Anzahl/Pcs. 1

14 Mutter, selbstsichernd  
Lock Nut



Feingewinde  
M10 DIN 985

Anzahl/Pcs. 1

13 Unterlegscheibe  
Washer



A 10,5 DIN 125

Anzahl/Pcs. 2

12 Sechskantschraube  
Hexagon Screw



Festigkeitsklasse 10.9  
M10 x 230 DIN 960

Anzahl/Pcs. 1

auf der rechten Seite Pos. 10 verwenden

Use pos. 10 on right side.

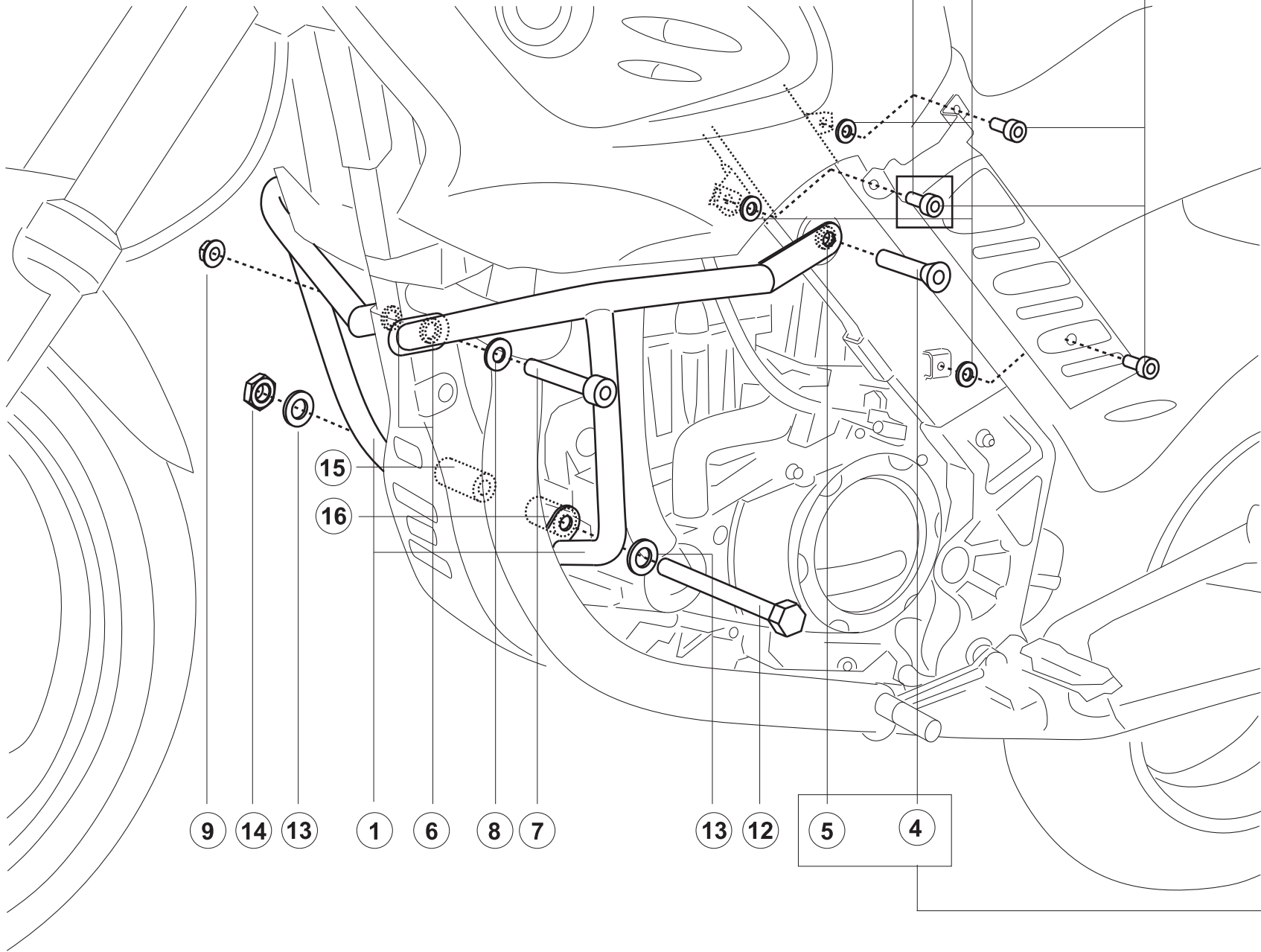

Vor der Montage Sitzbank,  
Tankverkleidung und Rahmenblenden  
entfernen.

Distanzbuchsen 3 5 6 15 16  
zwischen Schutzbügel und Rahmen  
montieren.

Remove seat, tank and frame protection

spacer 3 5 6 15 16  
between frame and crash bars

auf der rechten Seite mit Schraube

2 und Distanz 3  
verschrauben.

fix on right side with  
screw 2 and spacer 3